

## **Appendix C: Architecture Interconnect Diagrams**

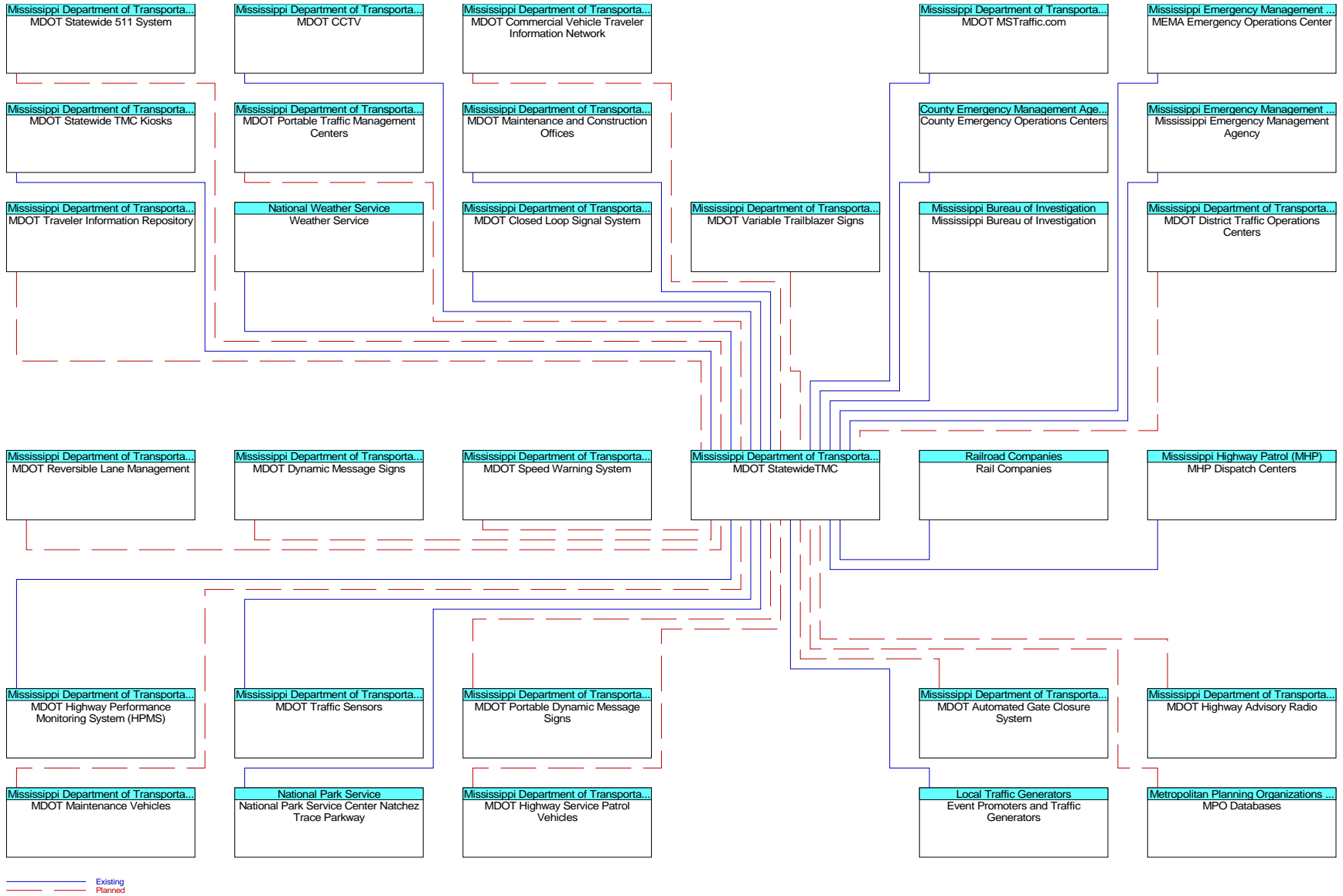

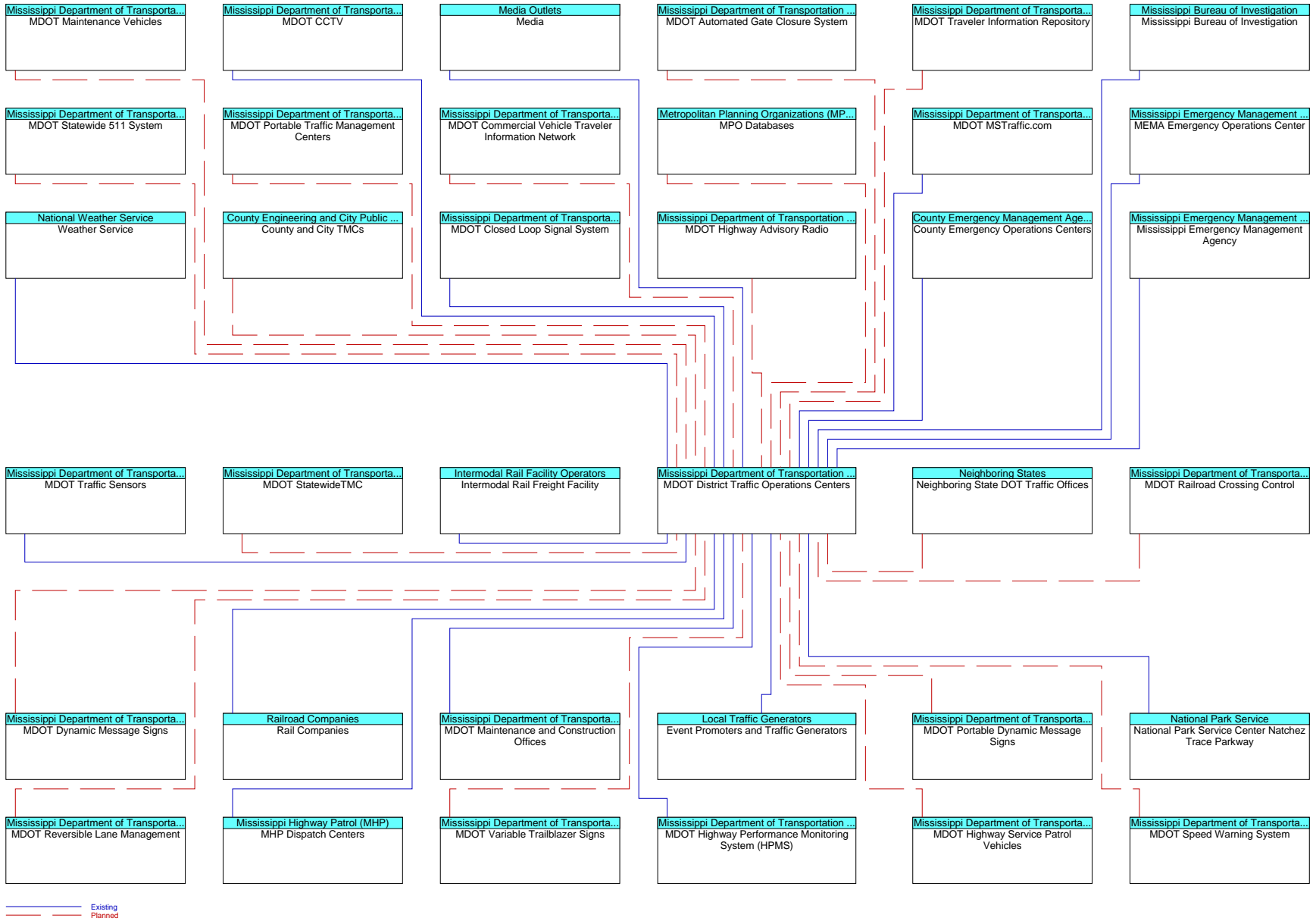

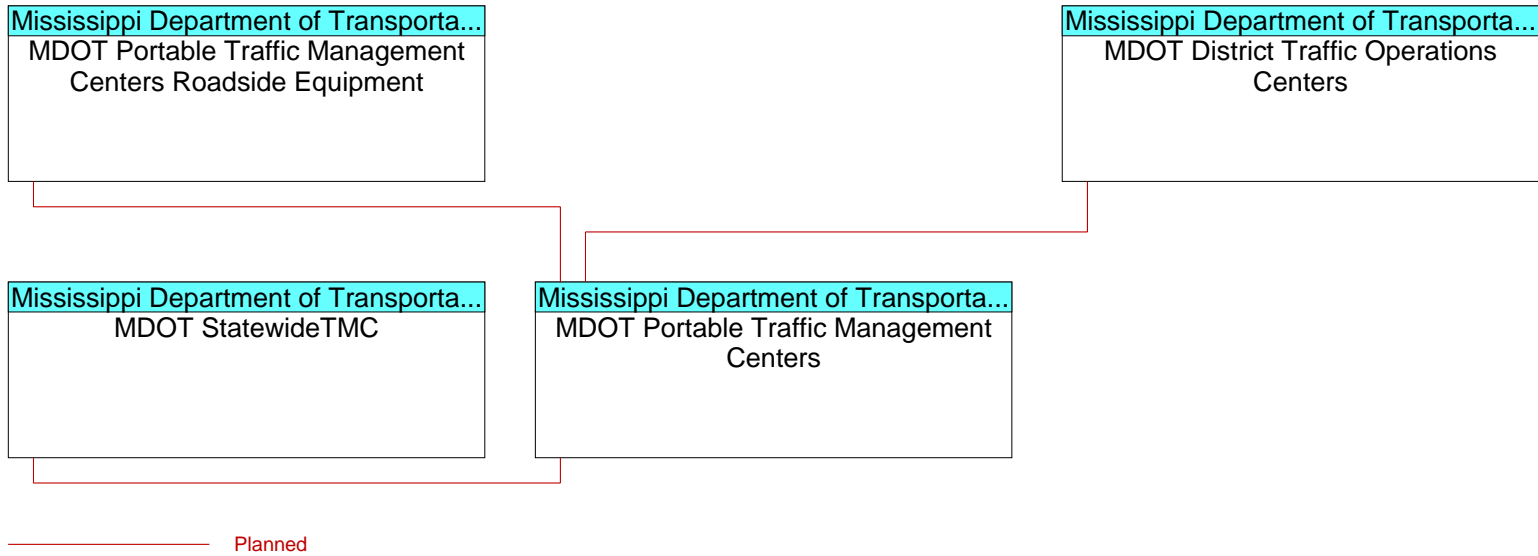



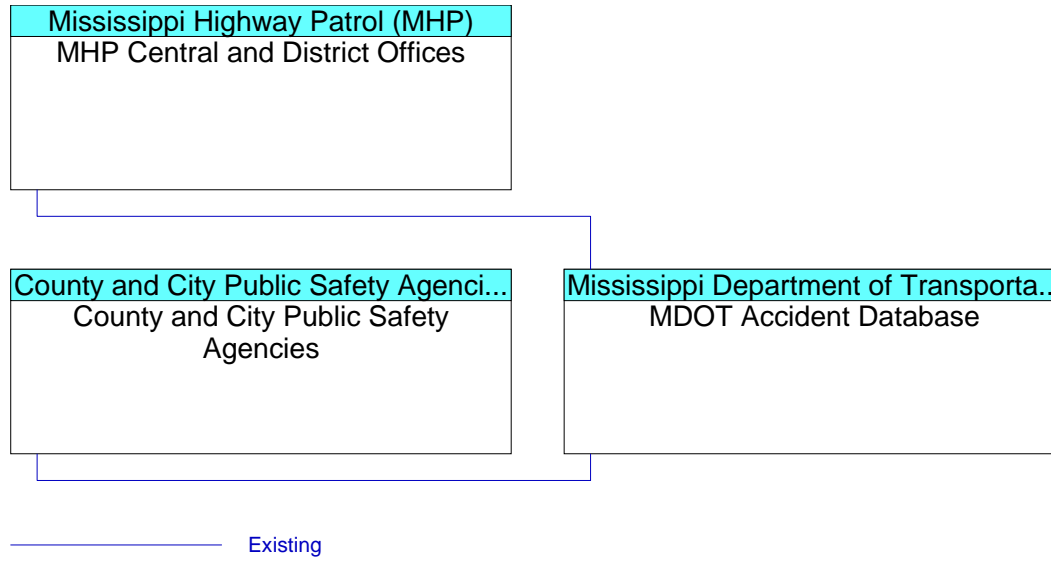

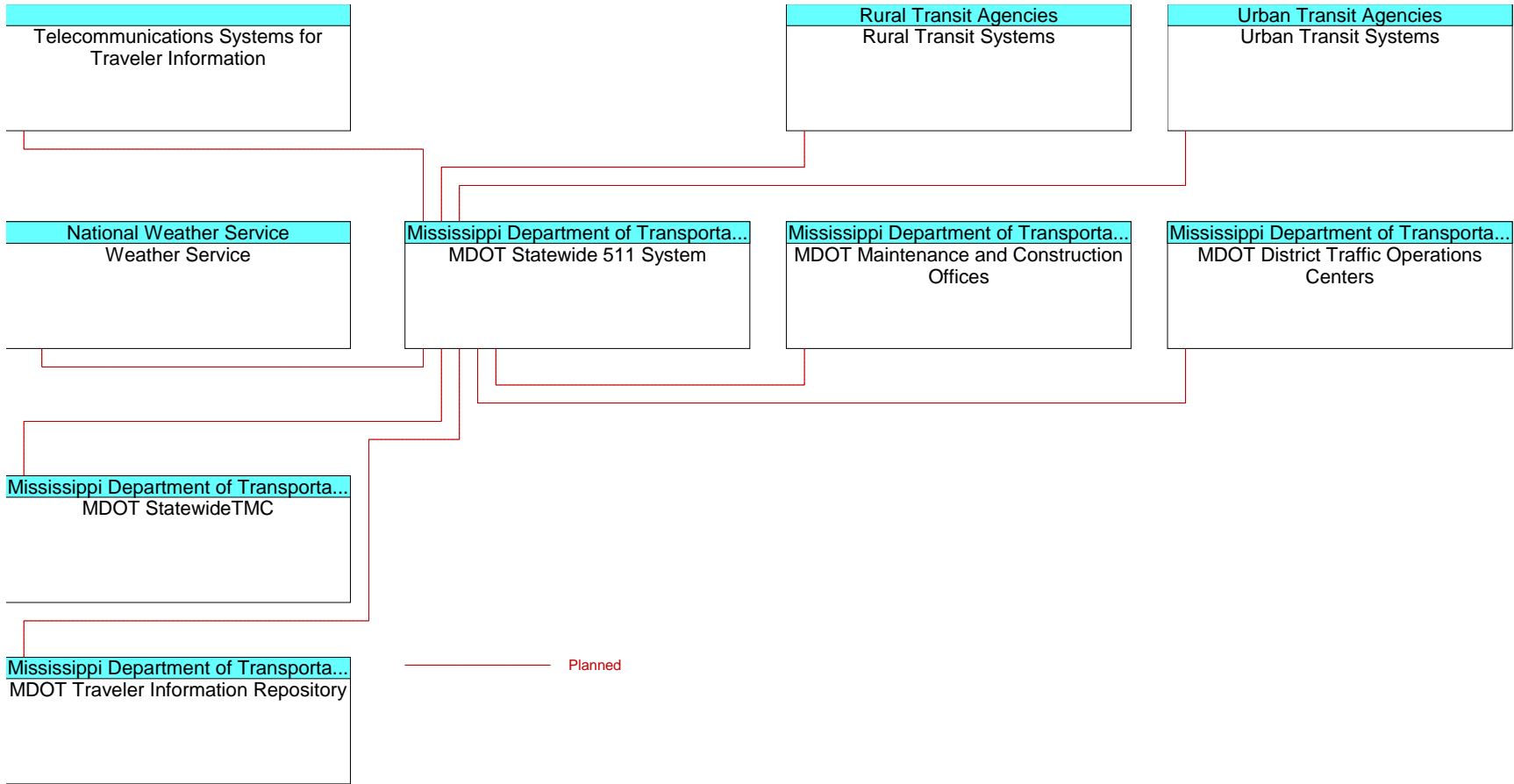

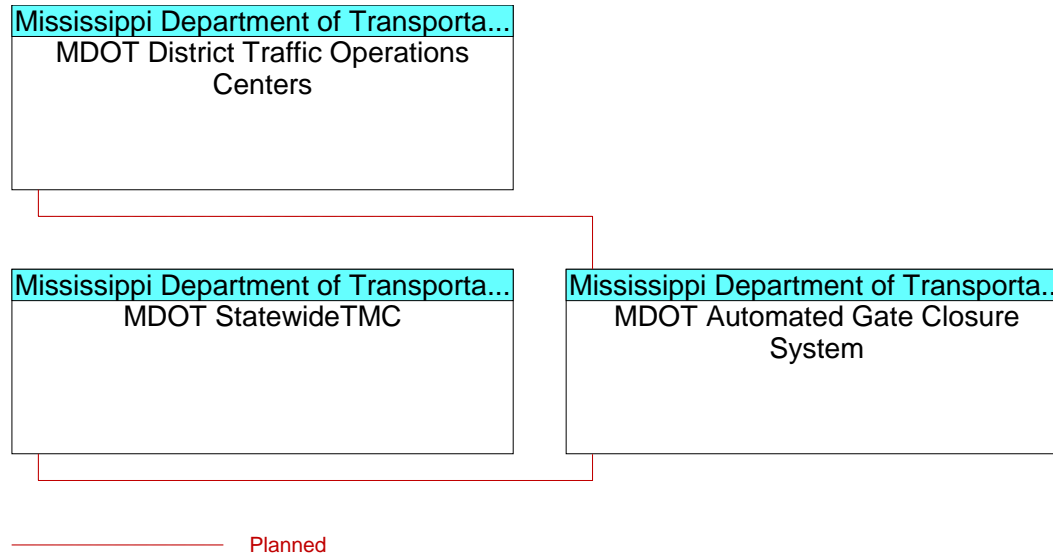

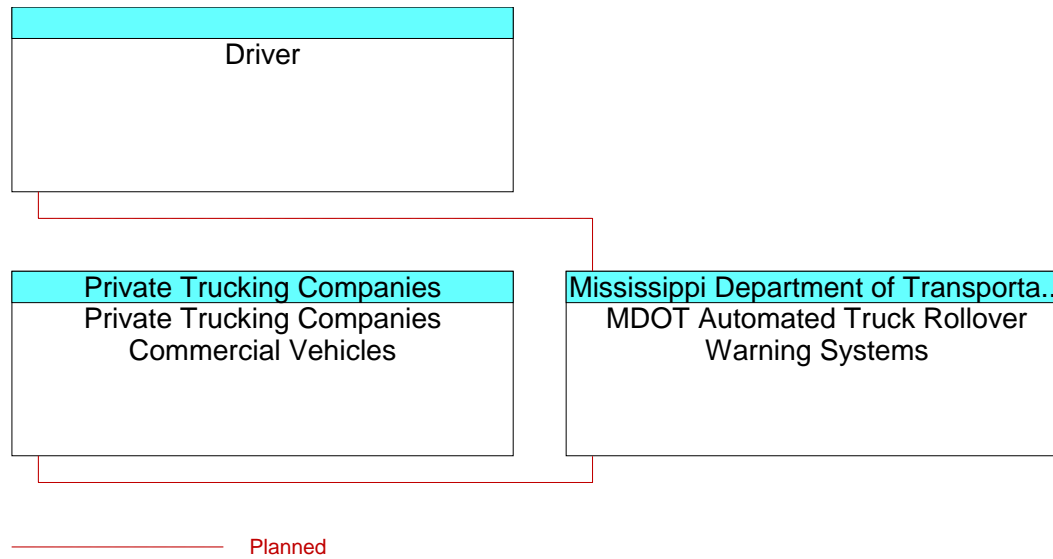

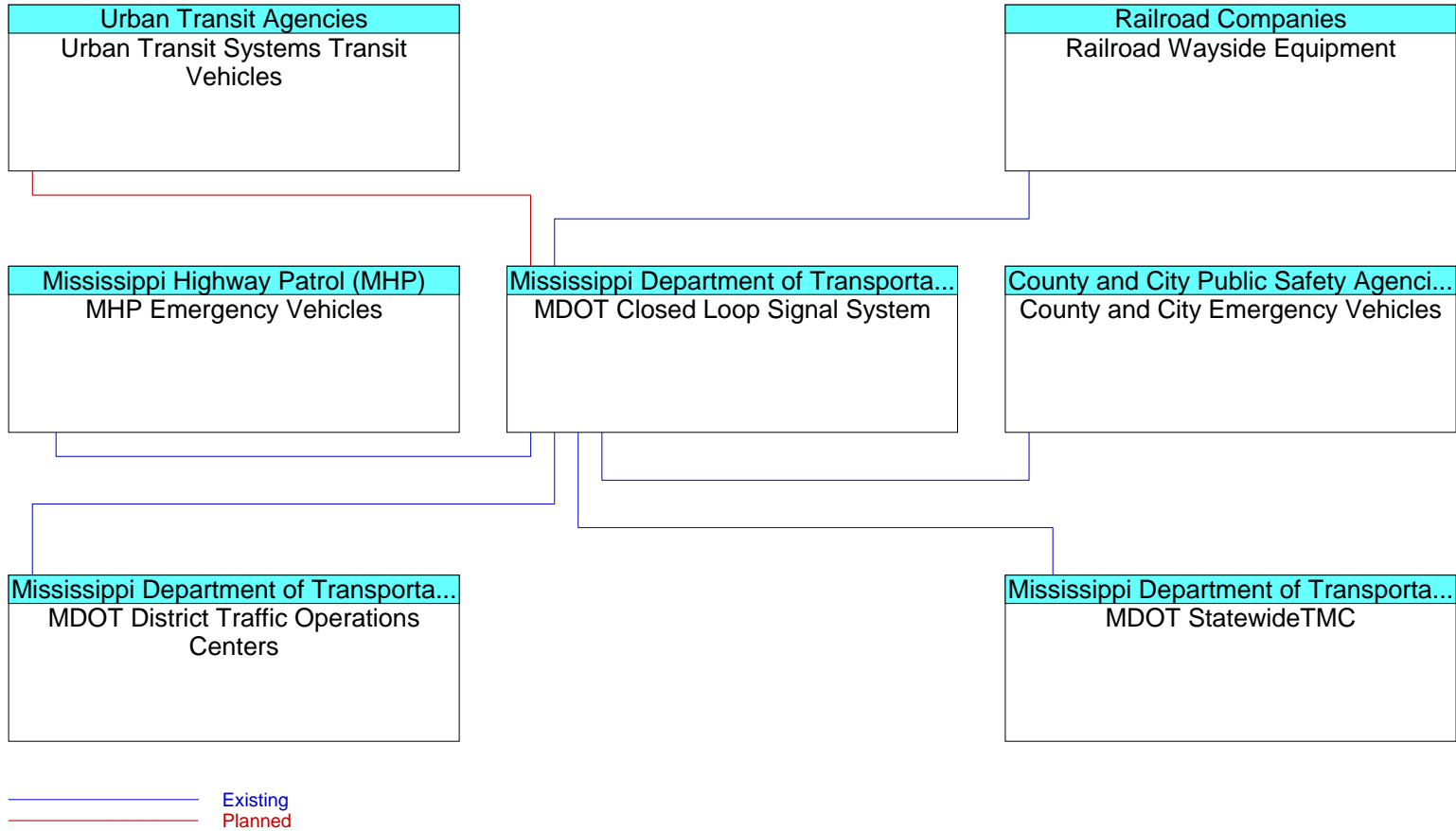

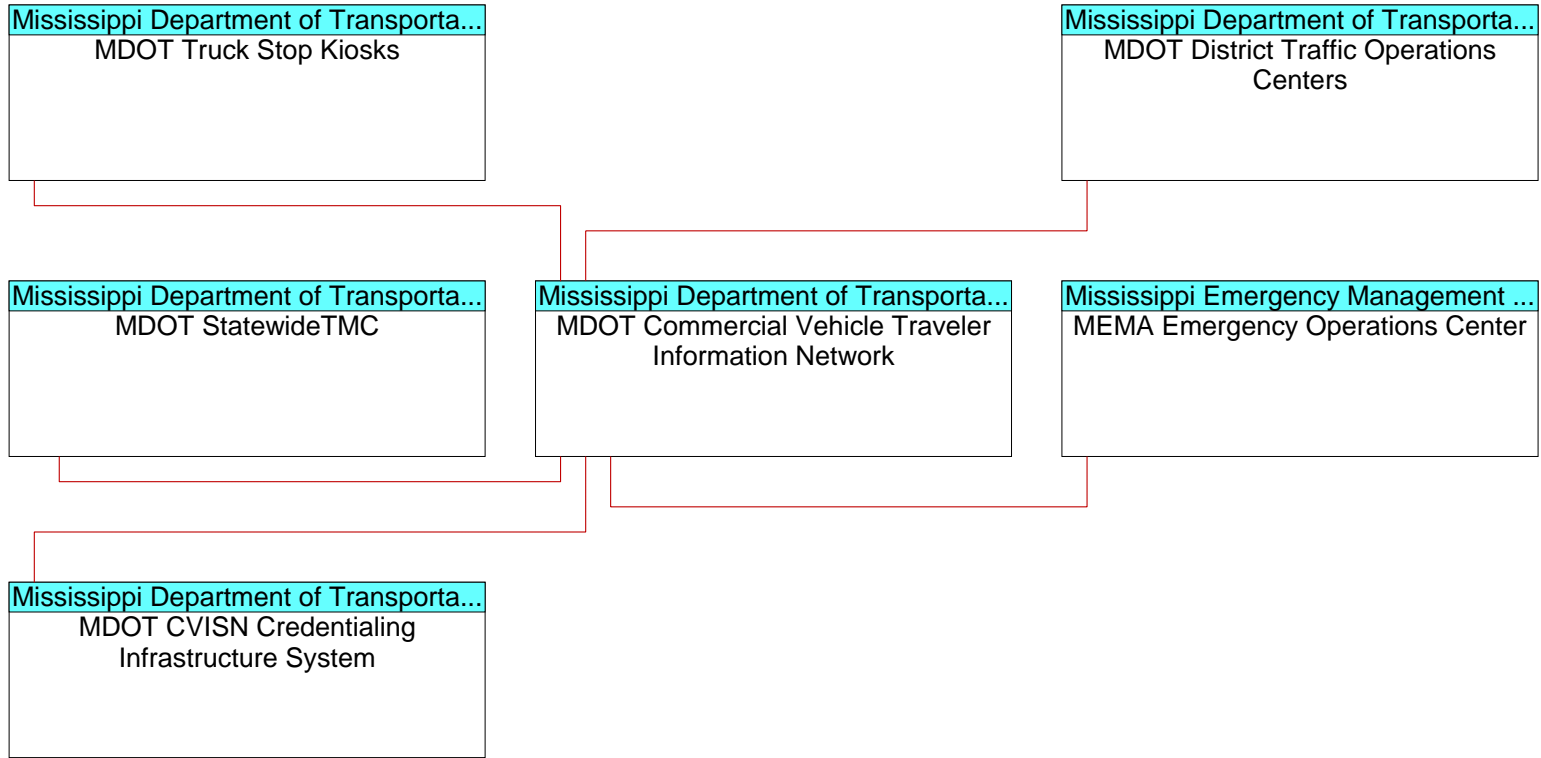

— Planned

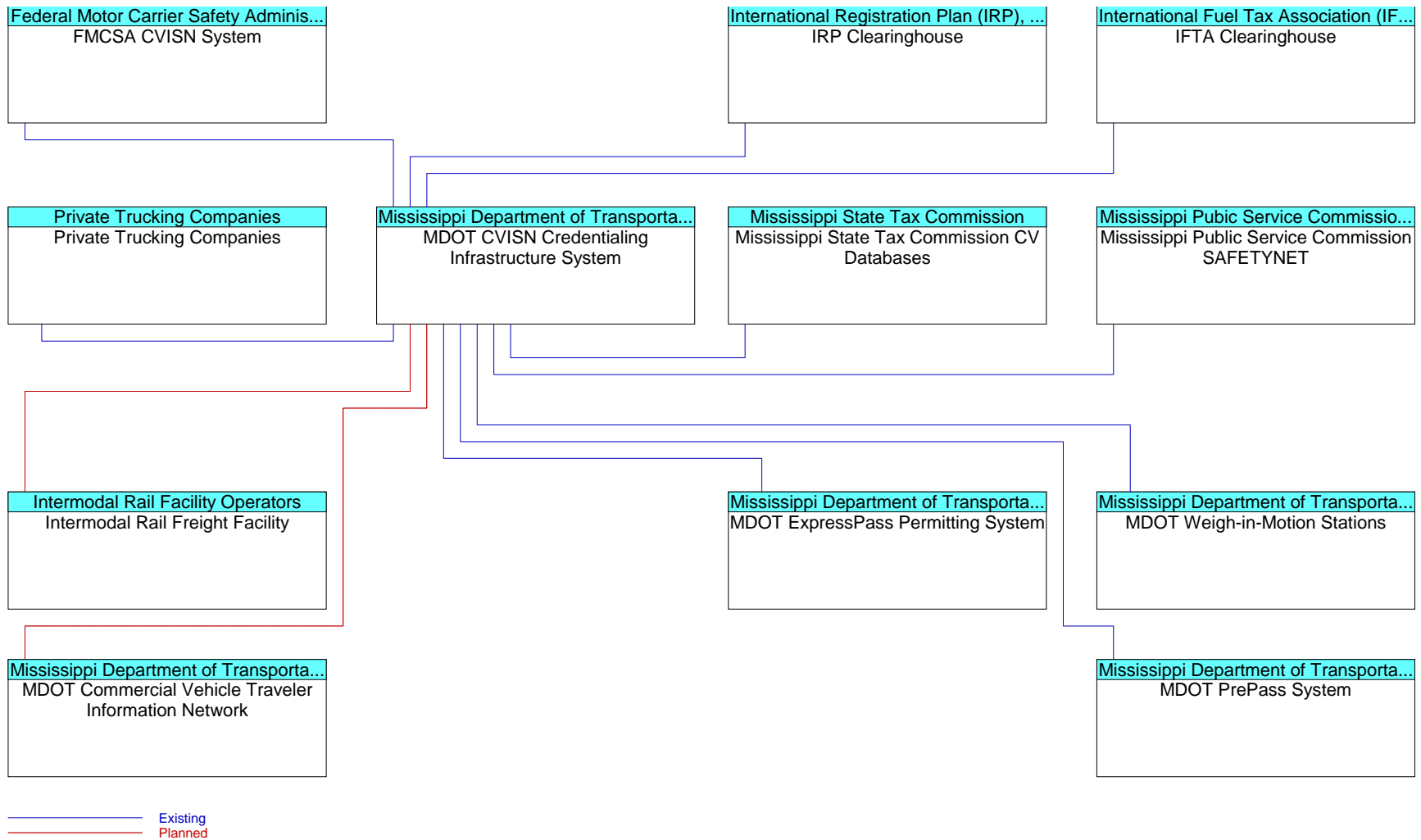

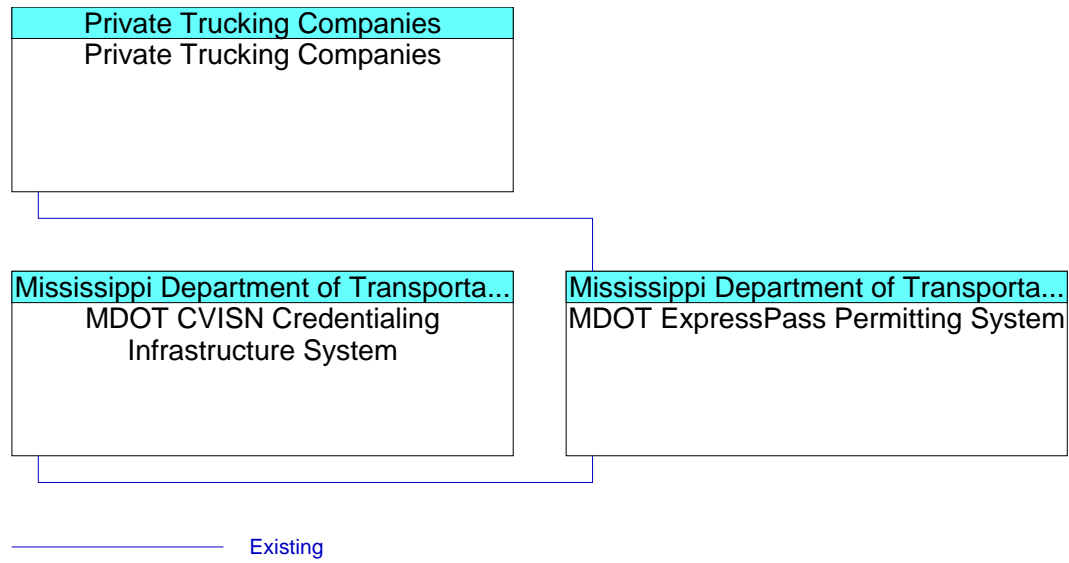

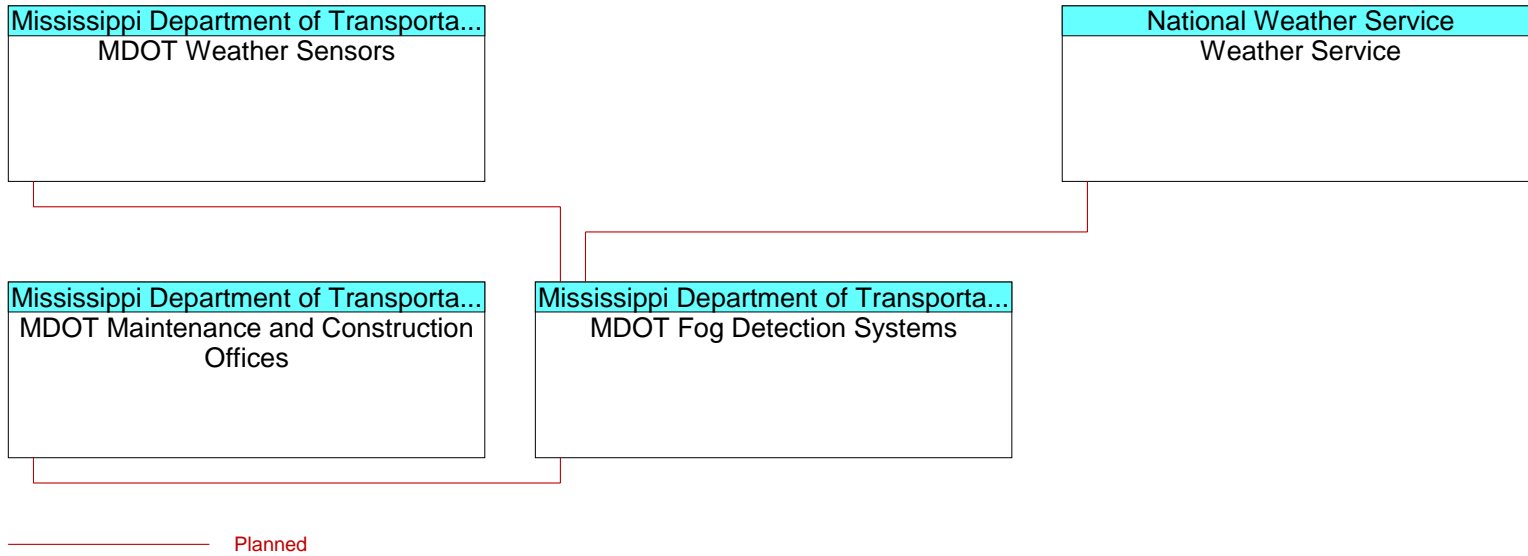

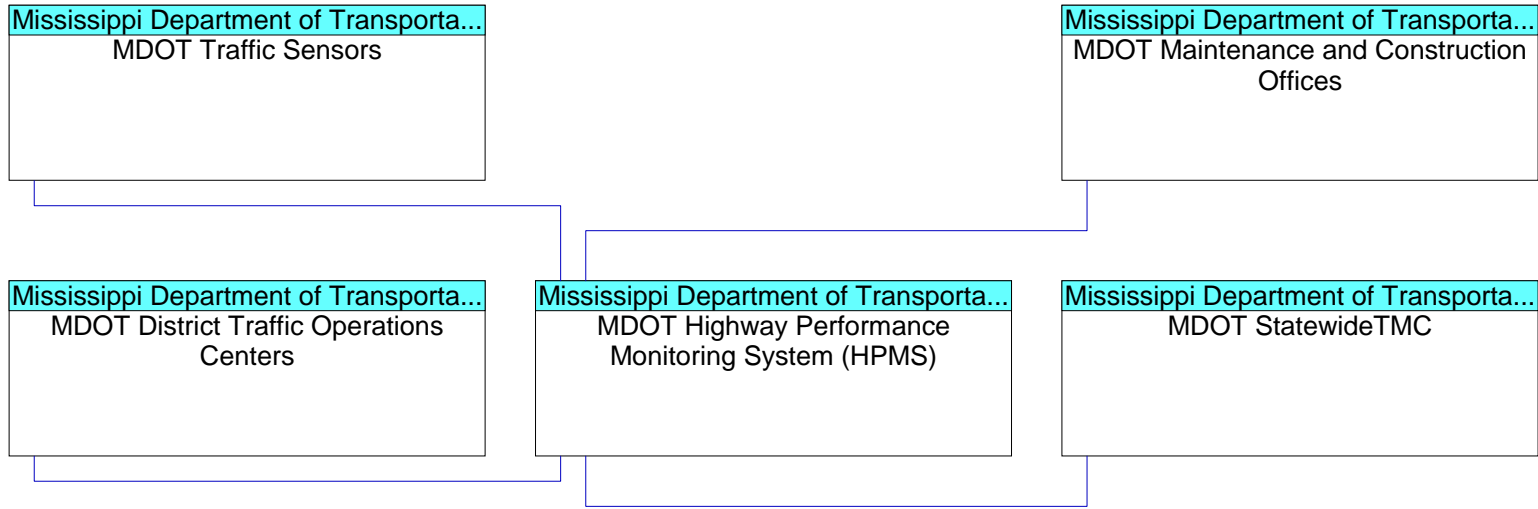

Existing

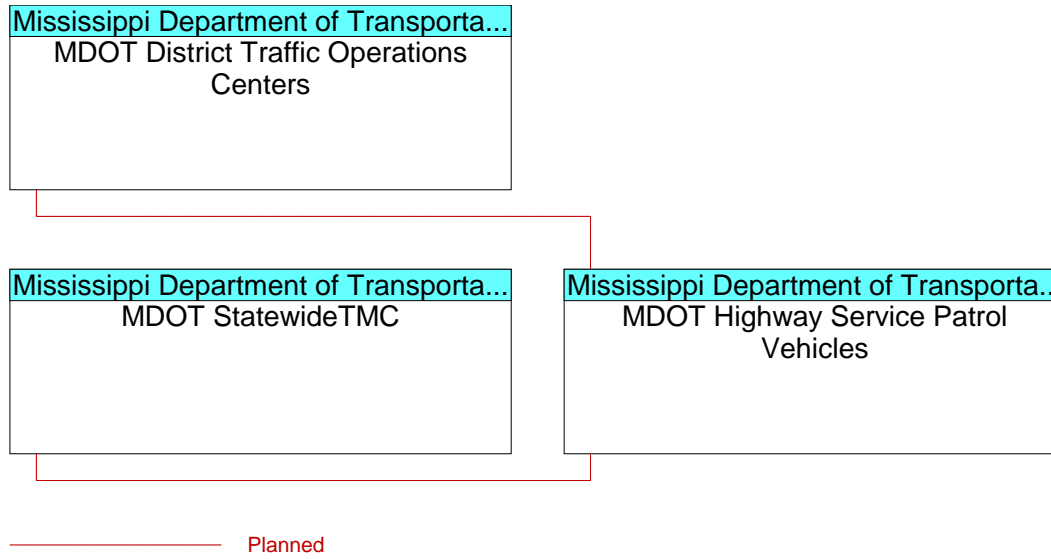

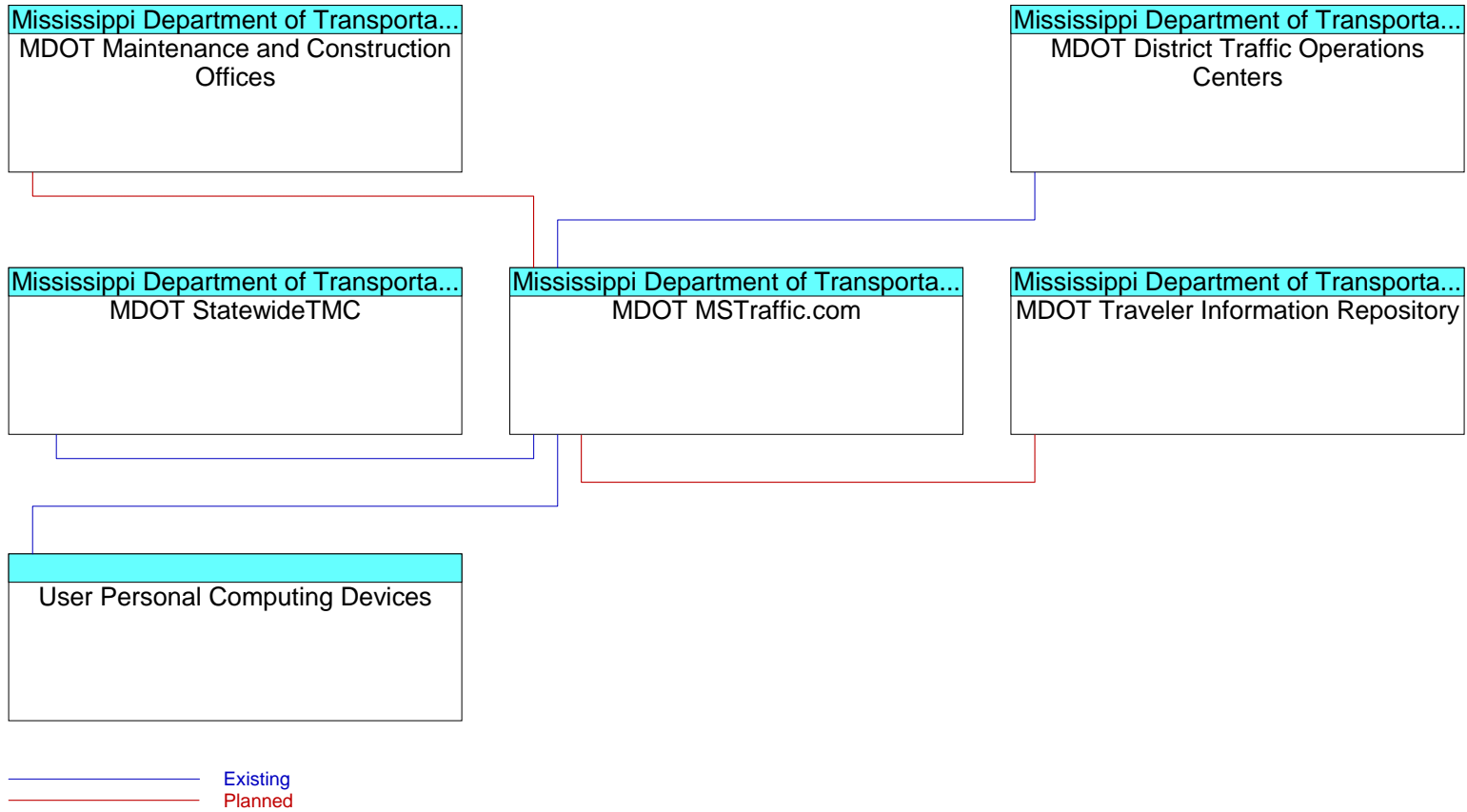

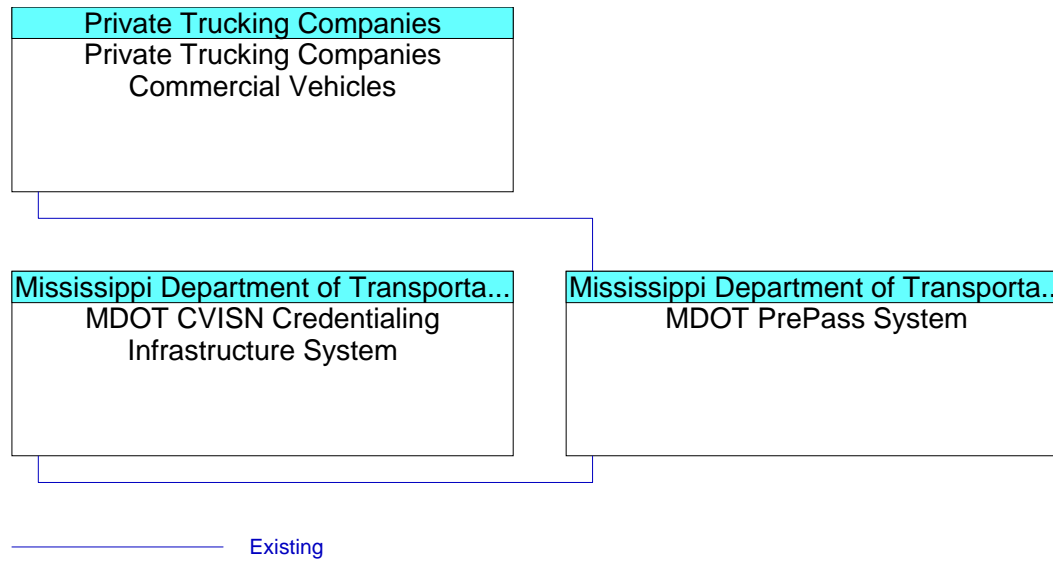

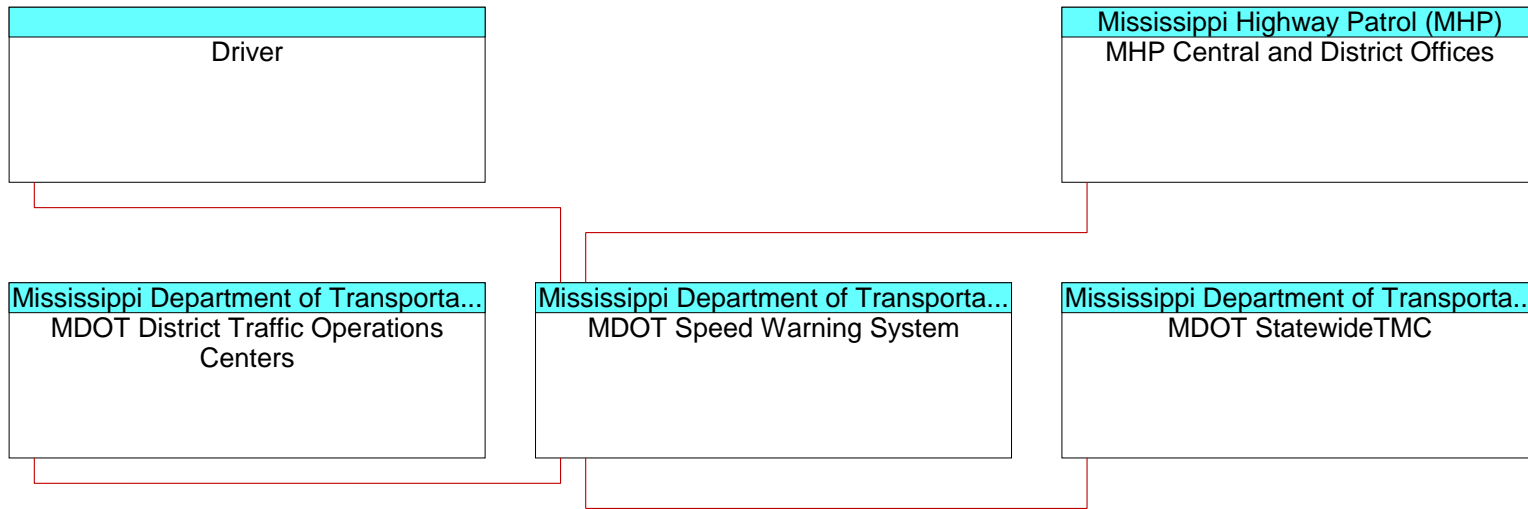

Planned

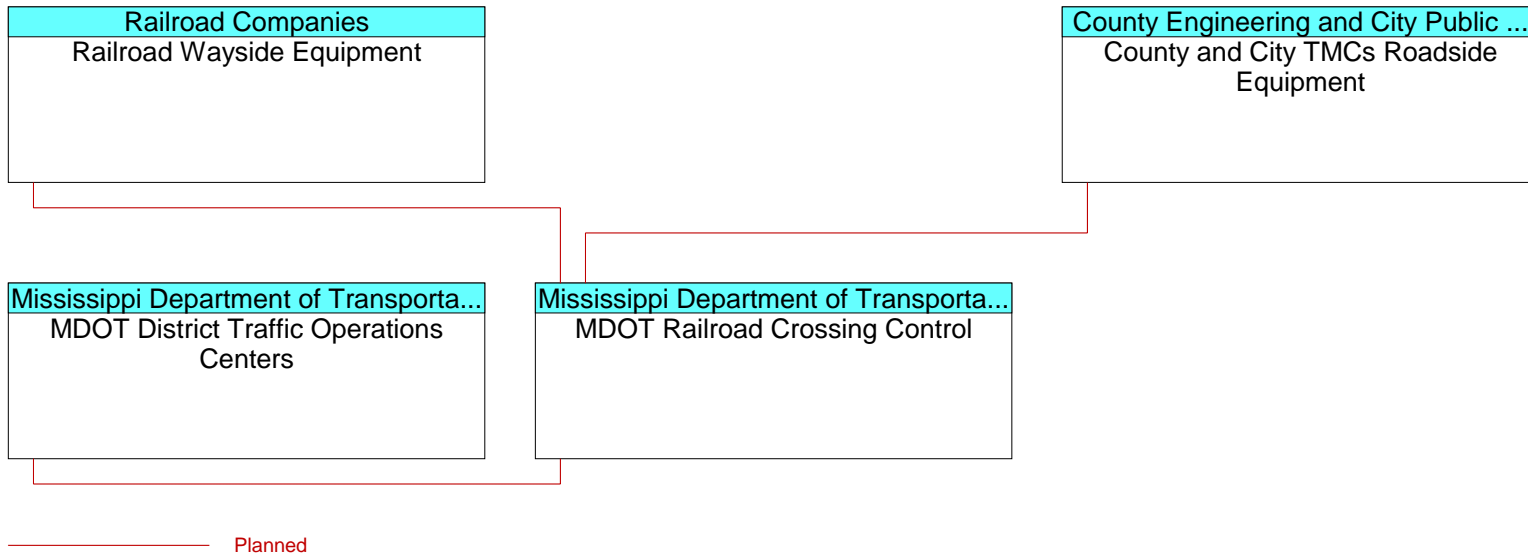

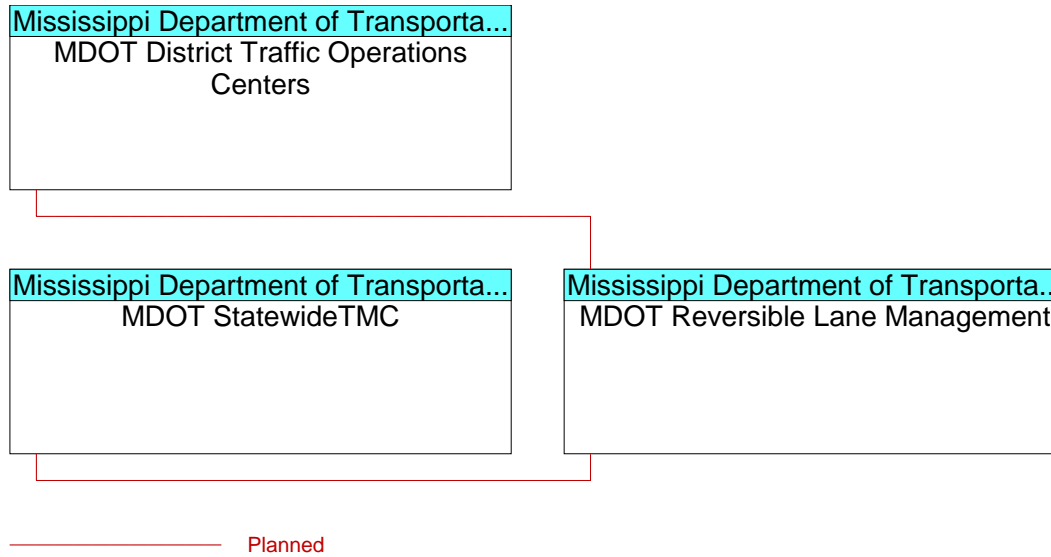

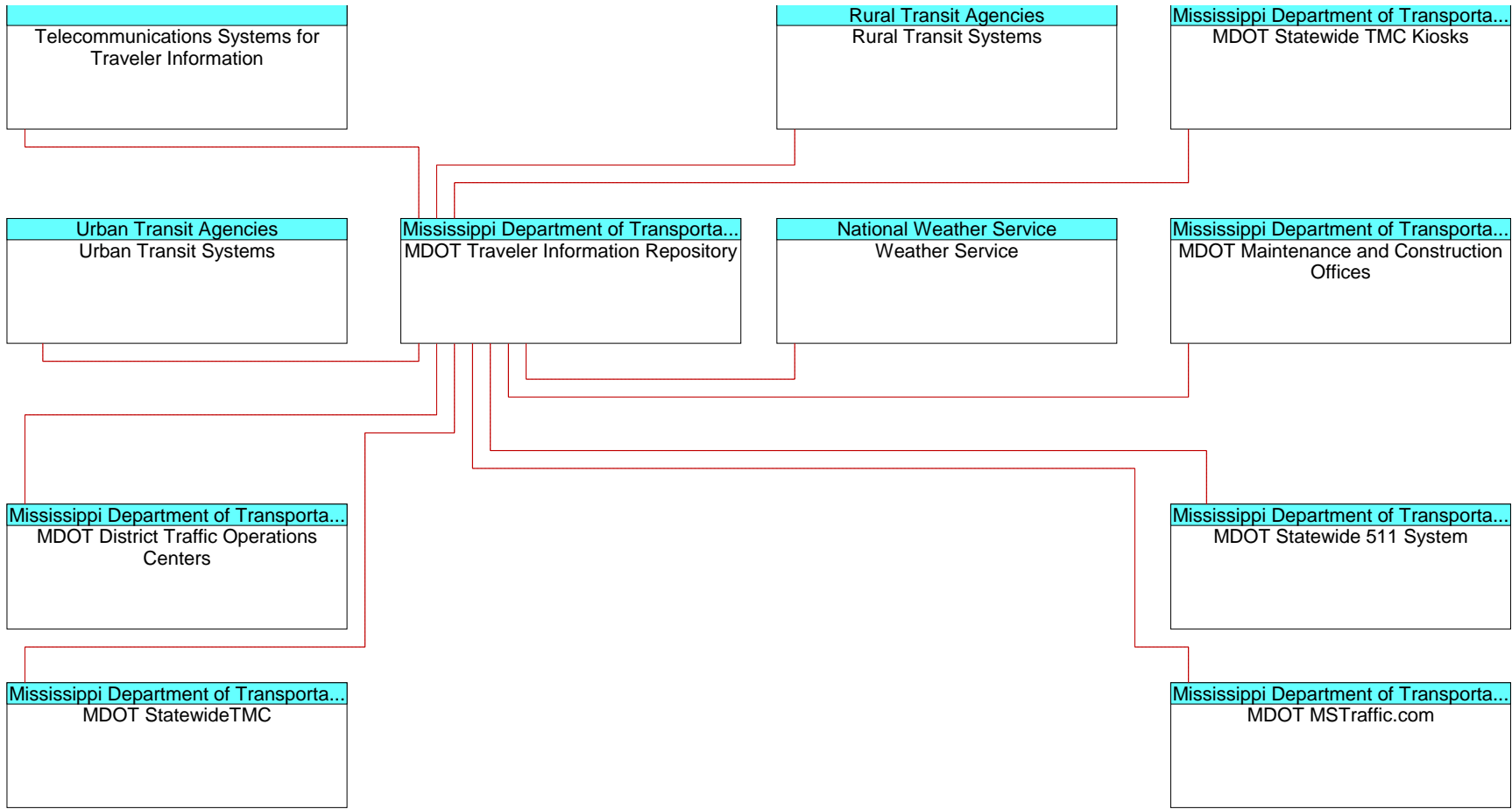

— Planned

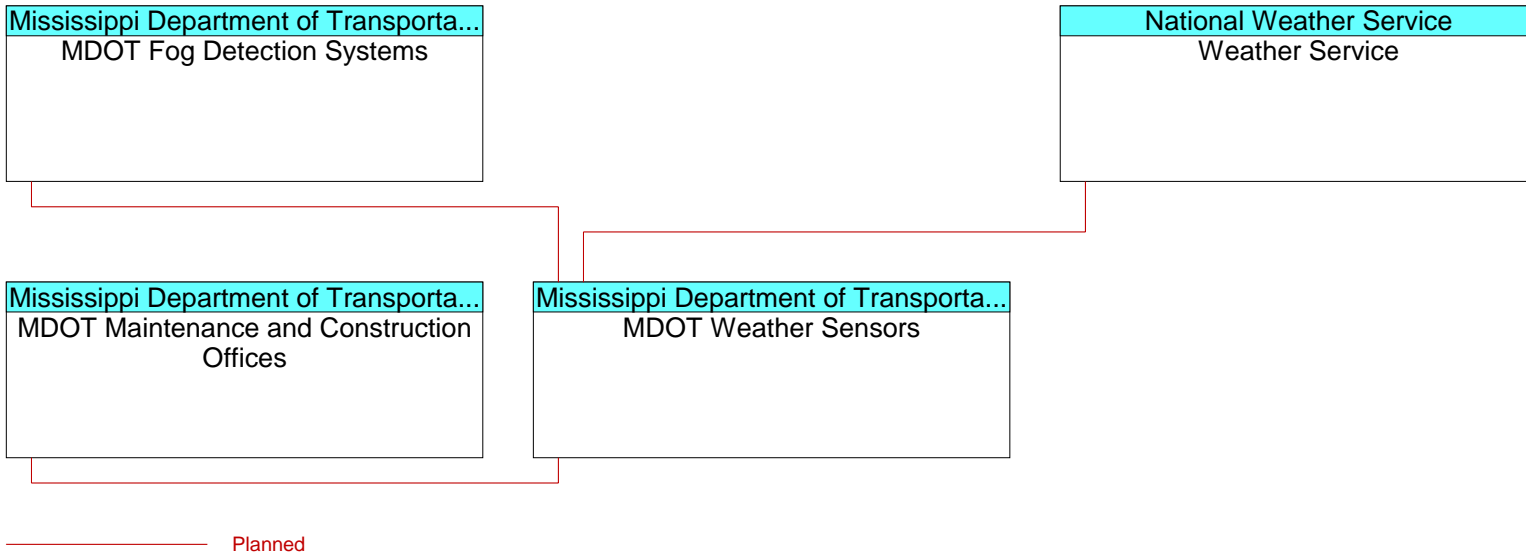

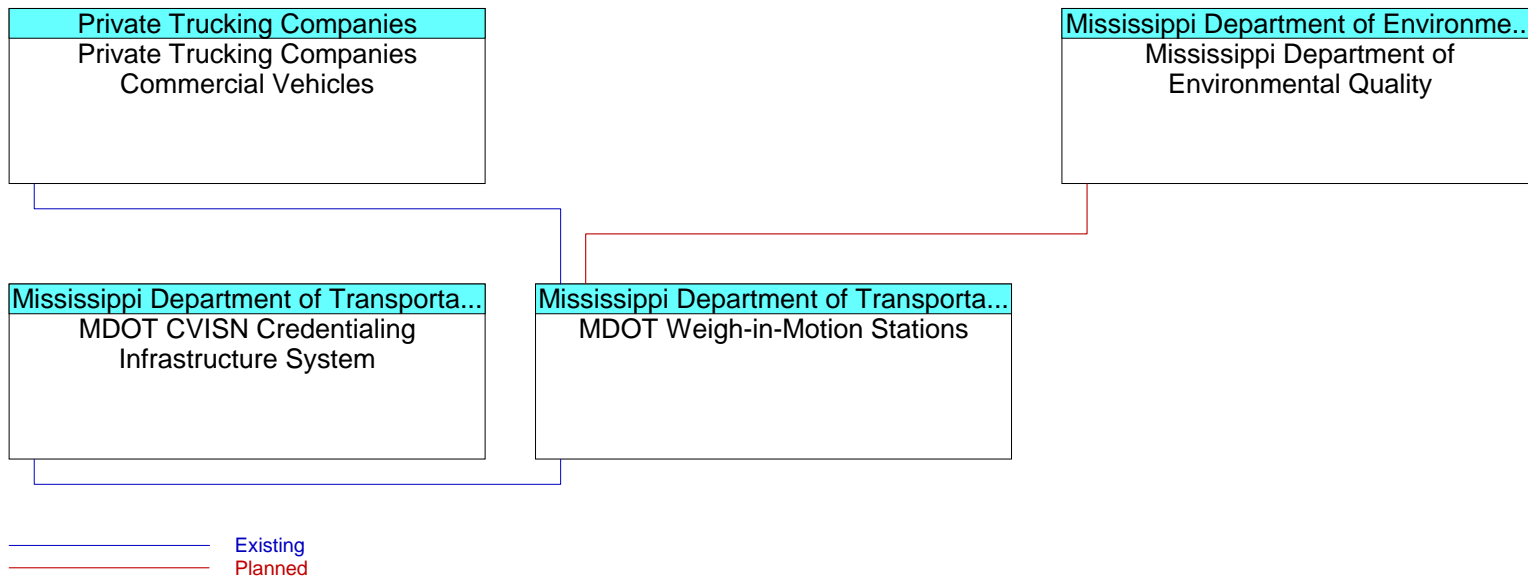

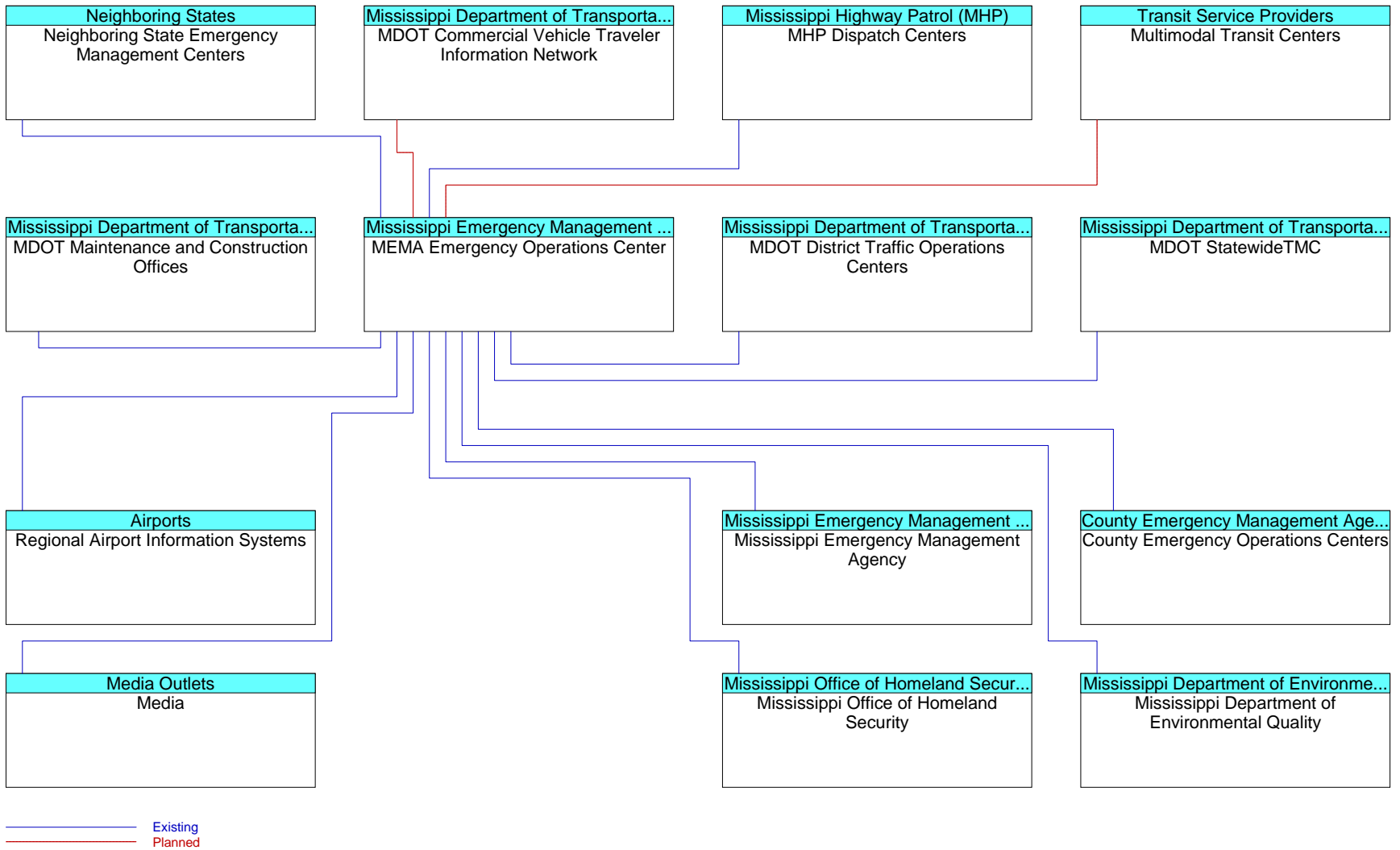

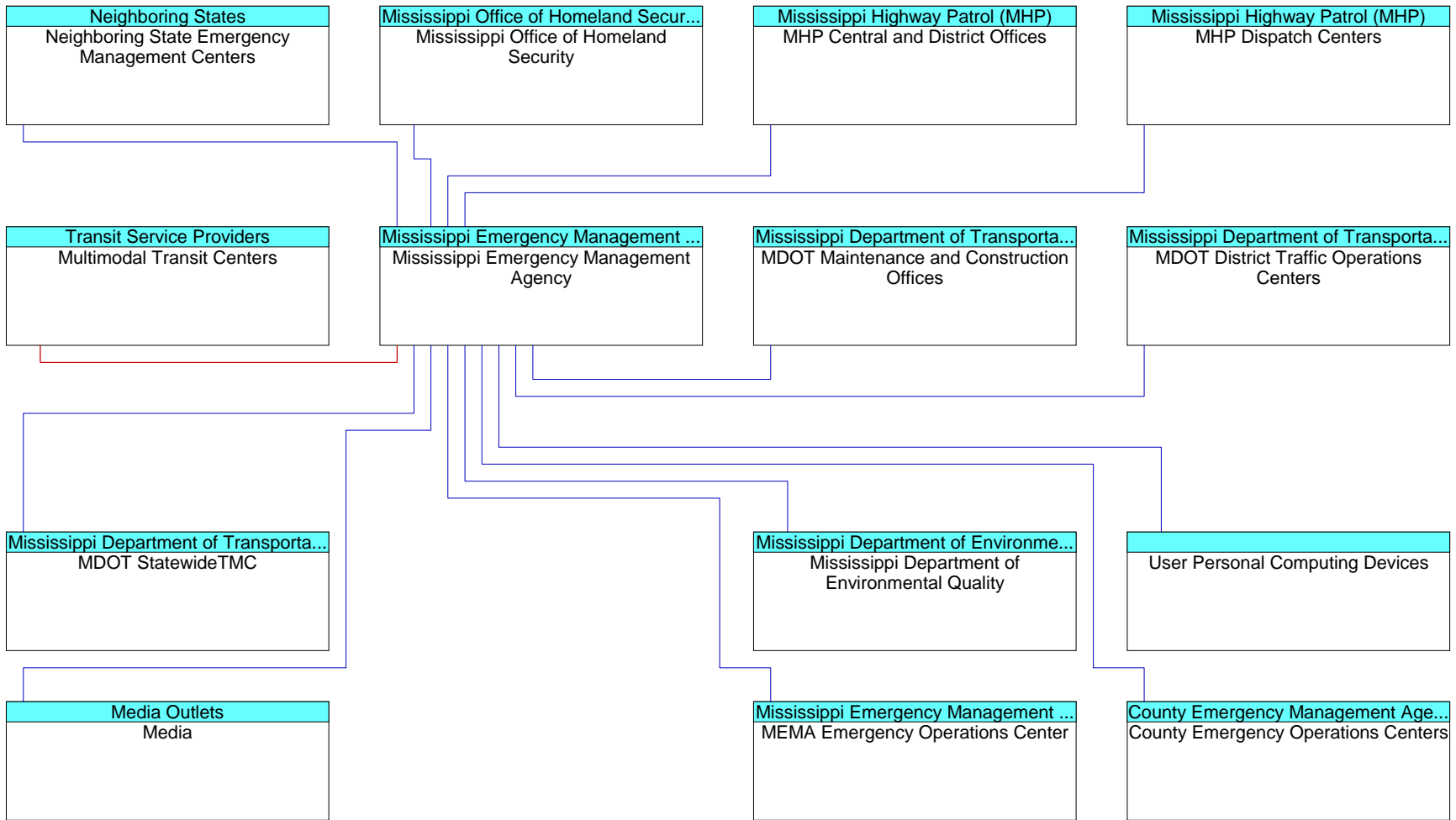

Existing  
Planned

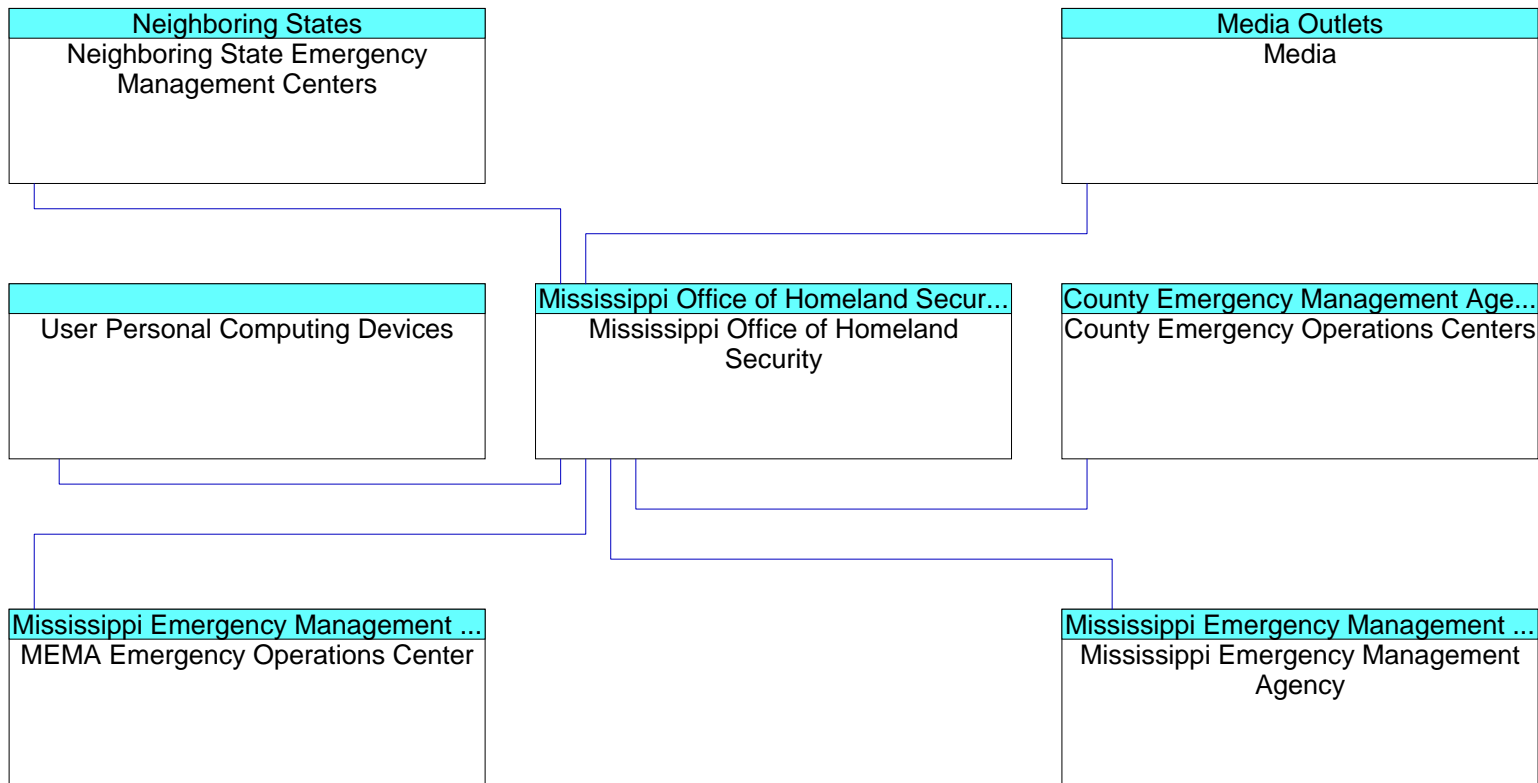

Existing

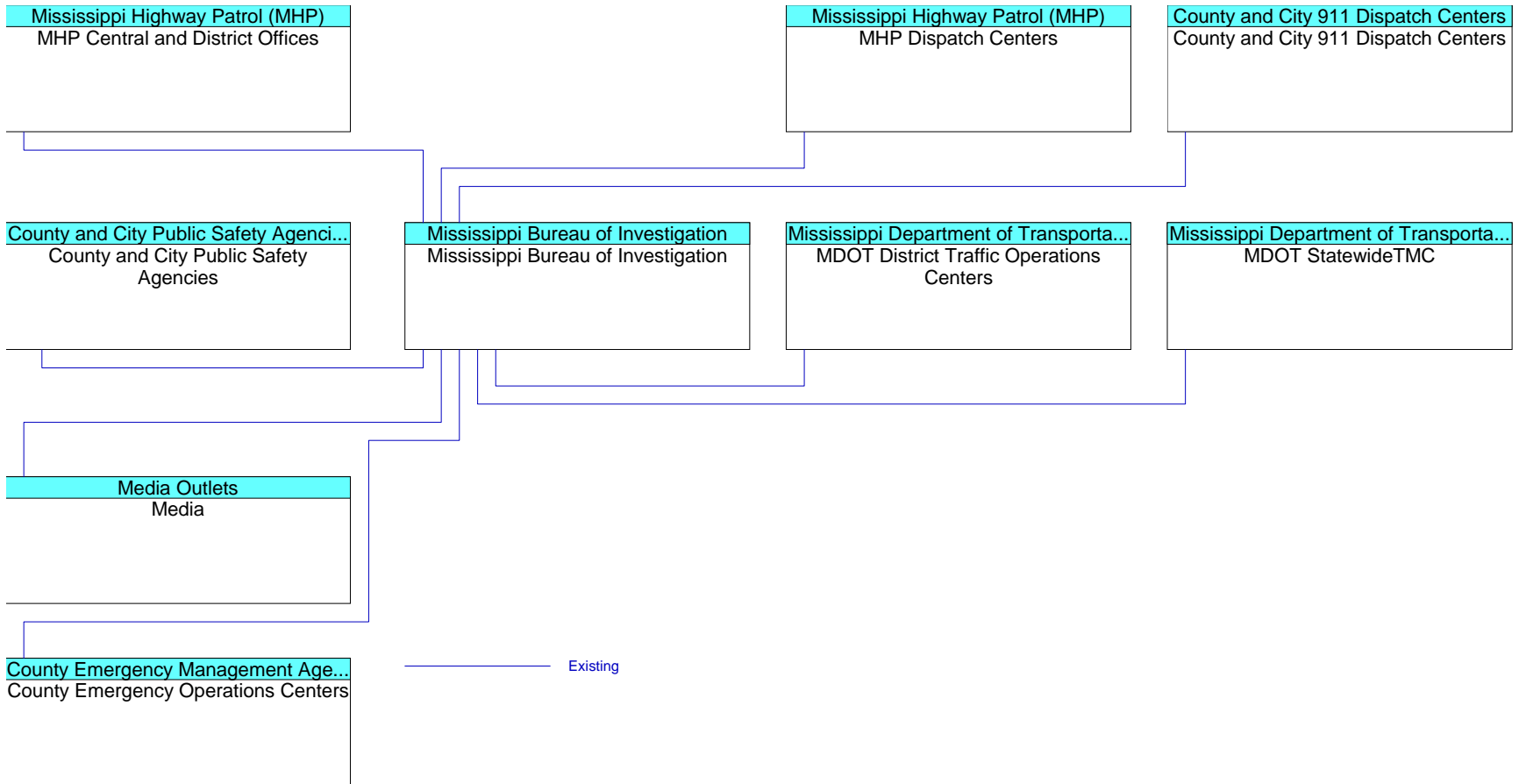

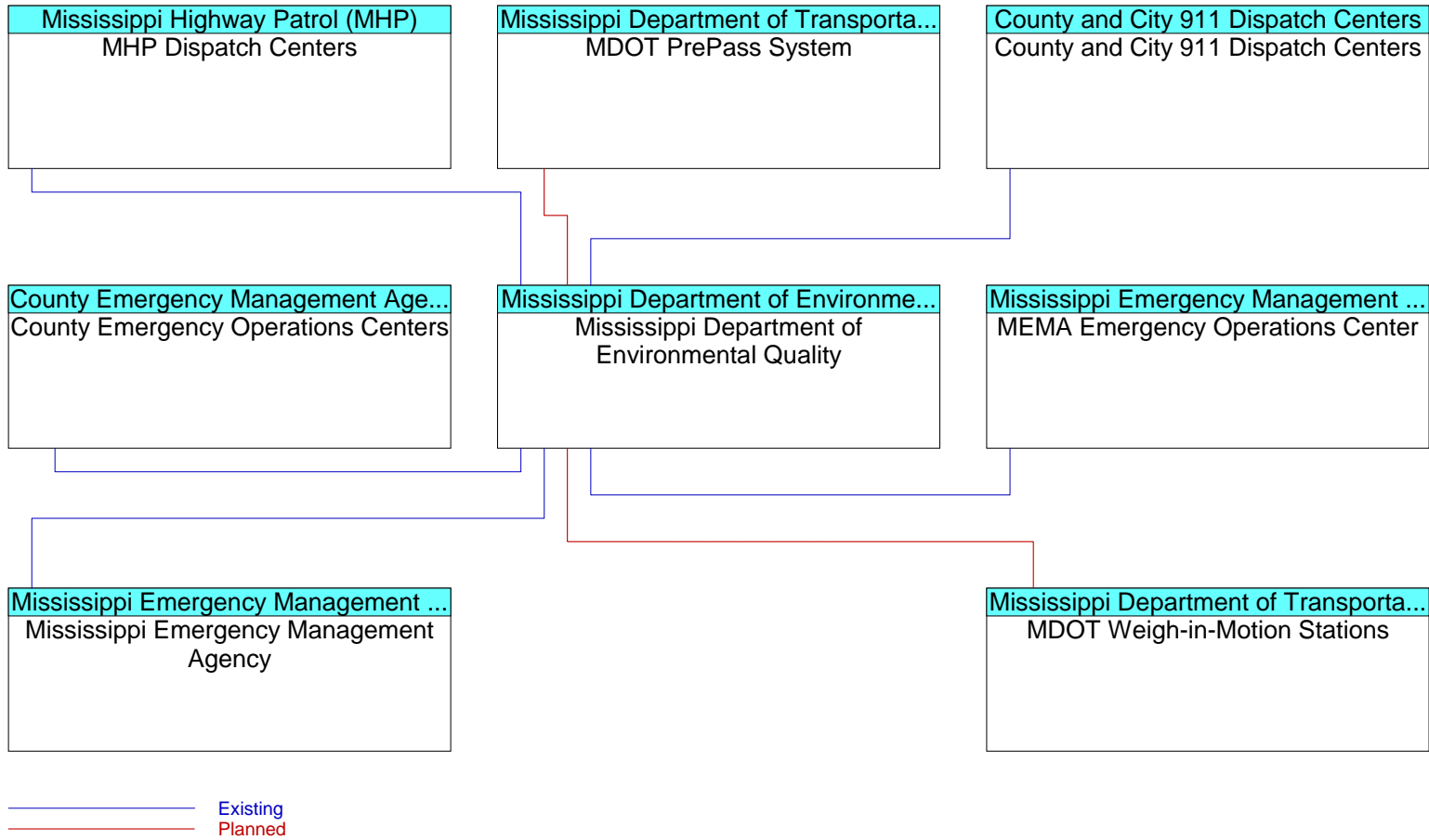

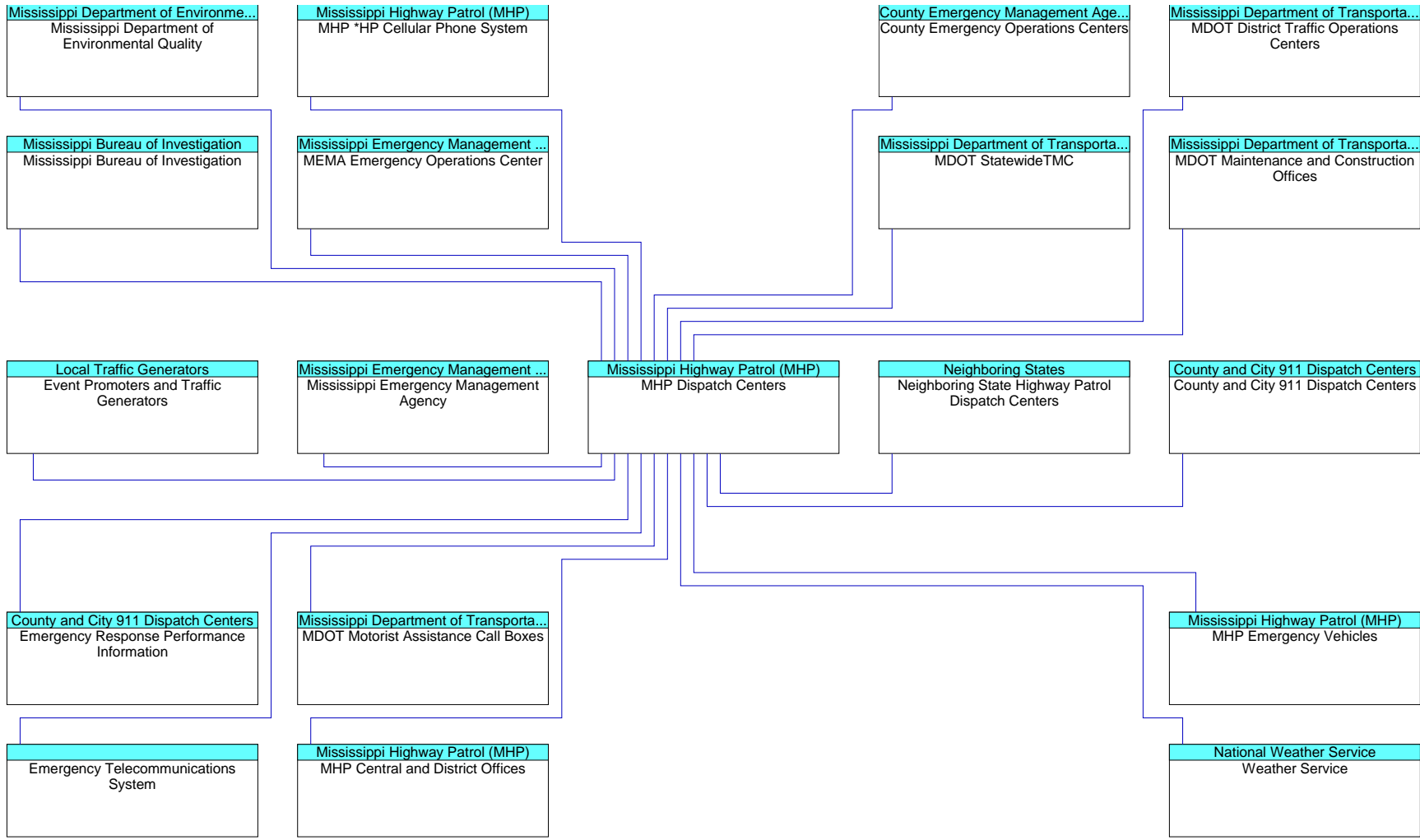

Existing

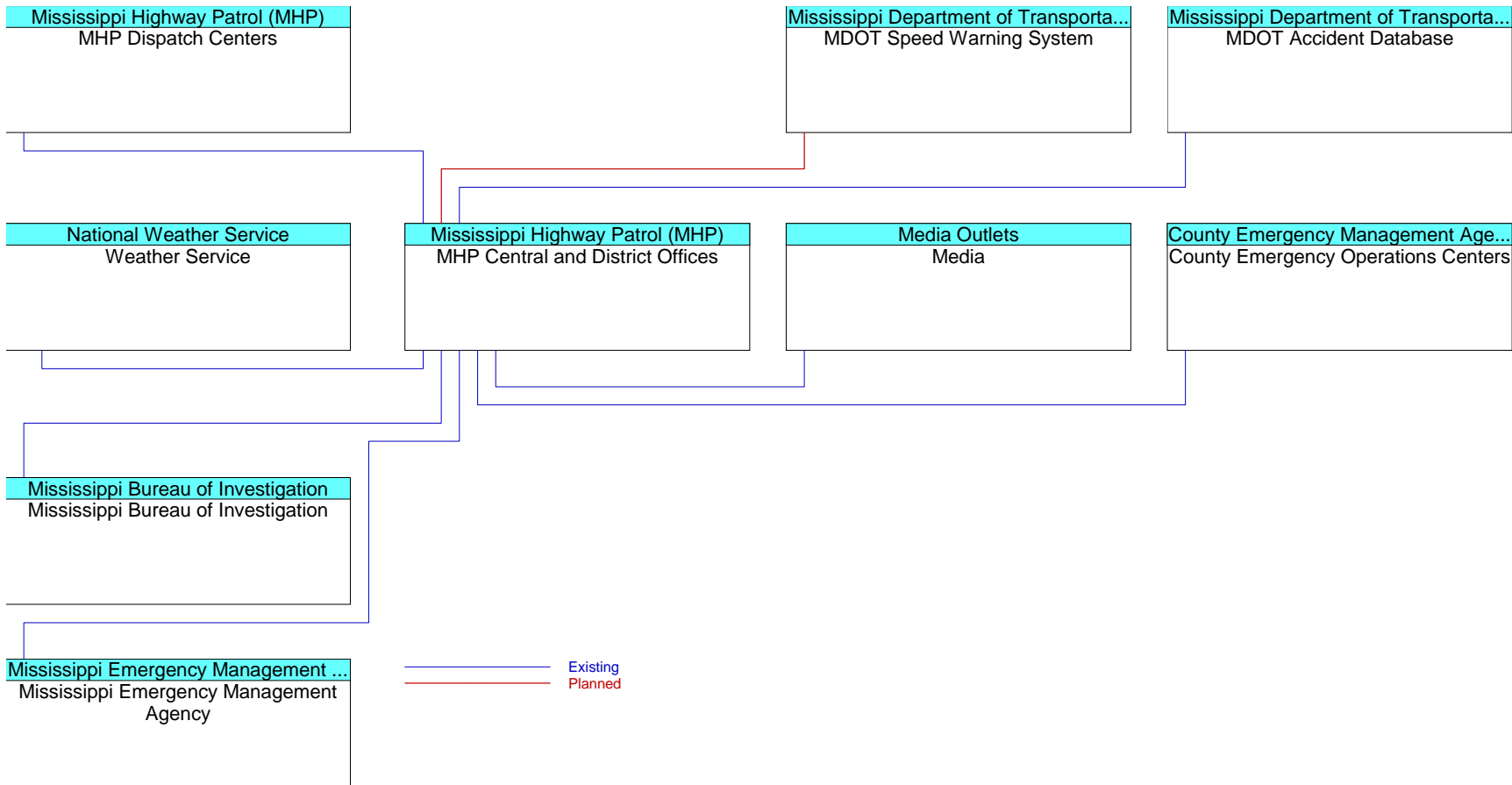

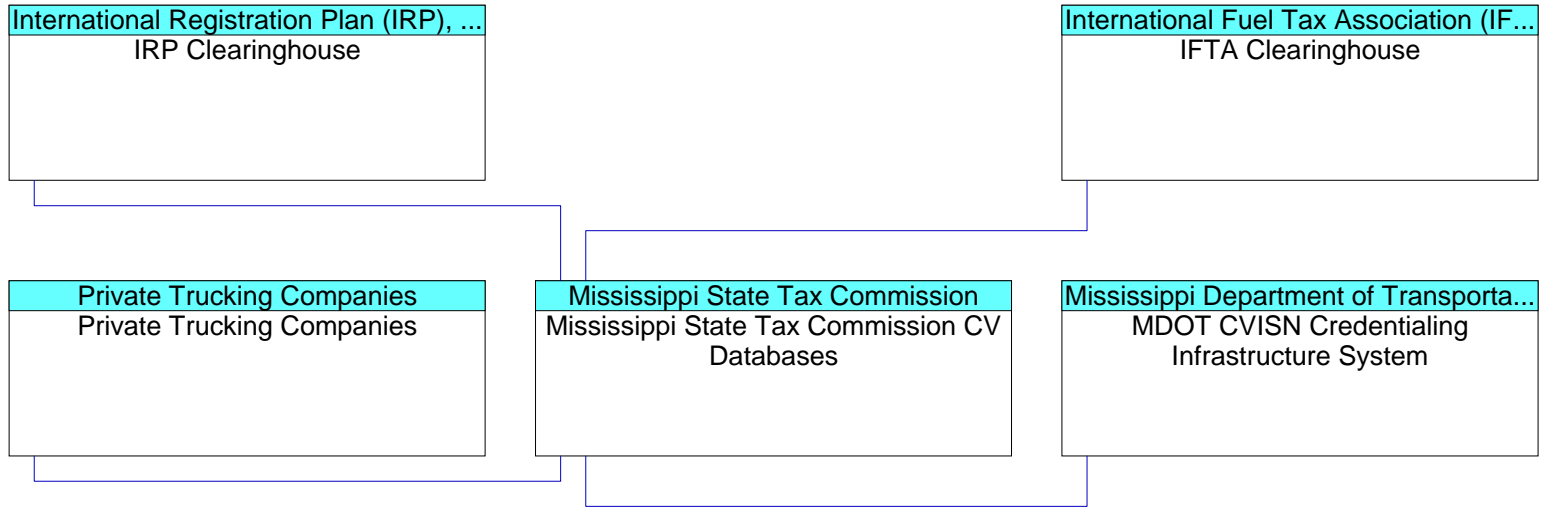

Existing

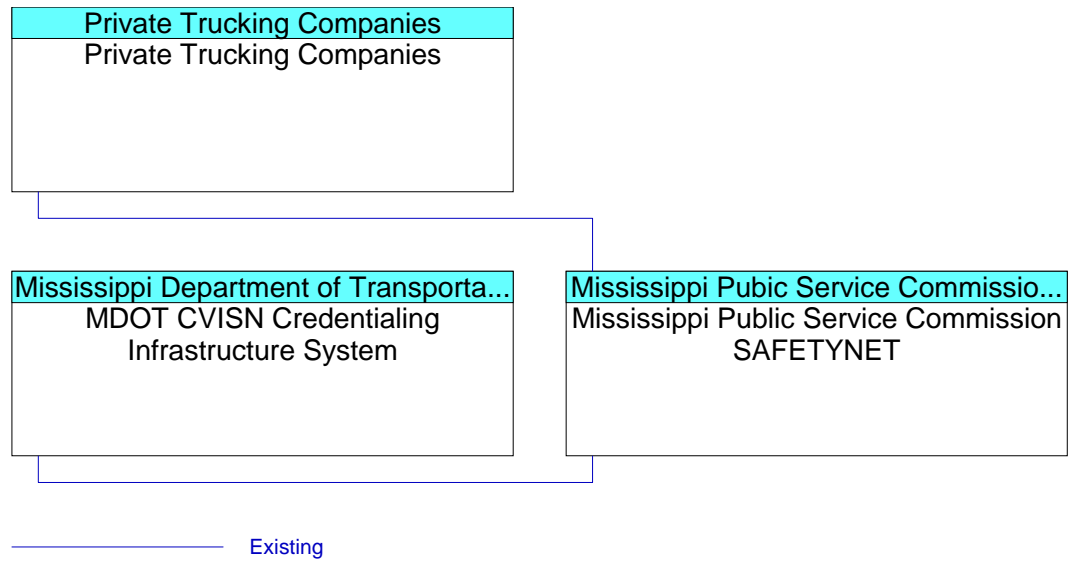

Mississippi Department of Public Saf...  
Mississippi Road/Weather Conditions  
Website

User Personal Computing Devices

Existing

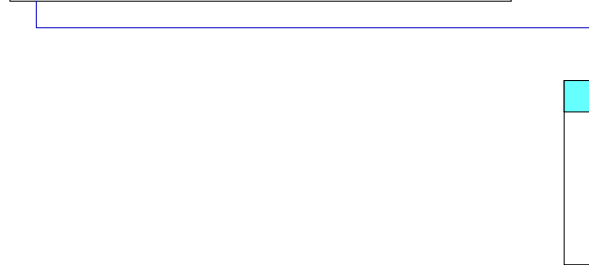

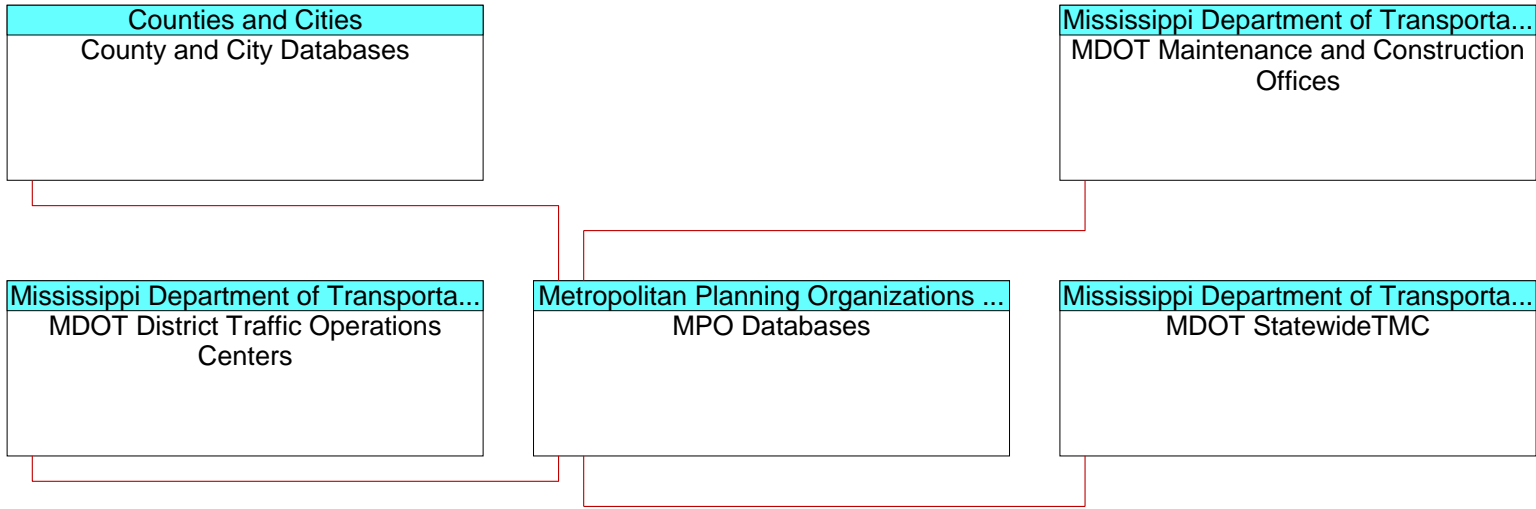

— Planned

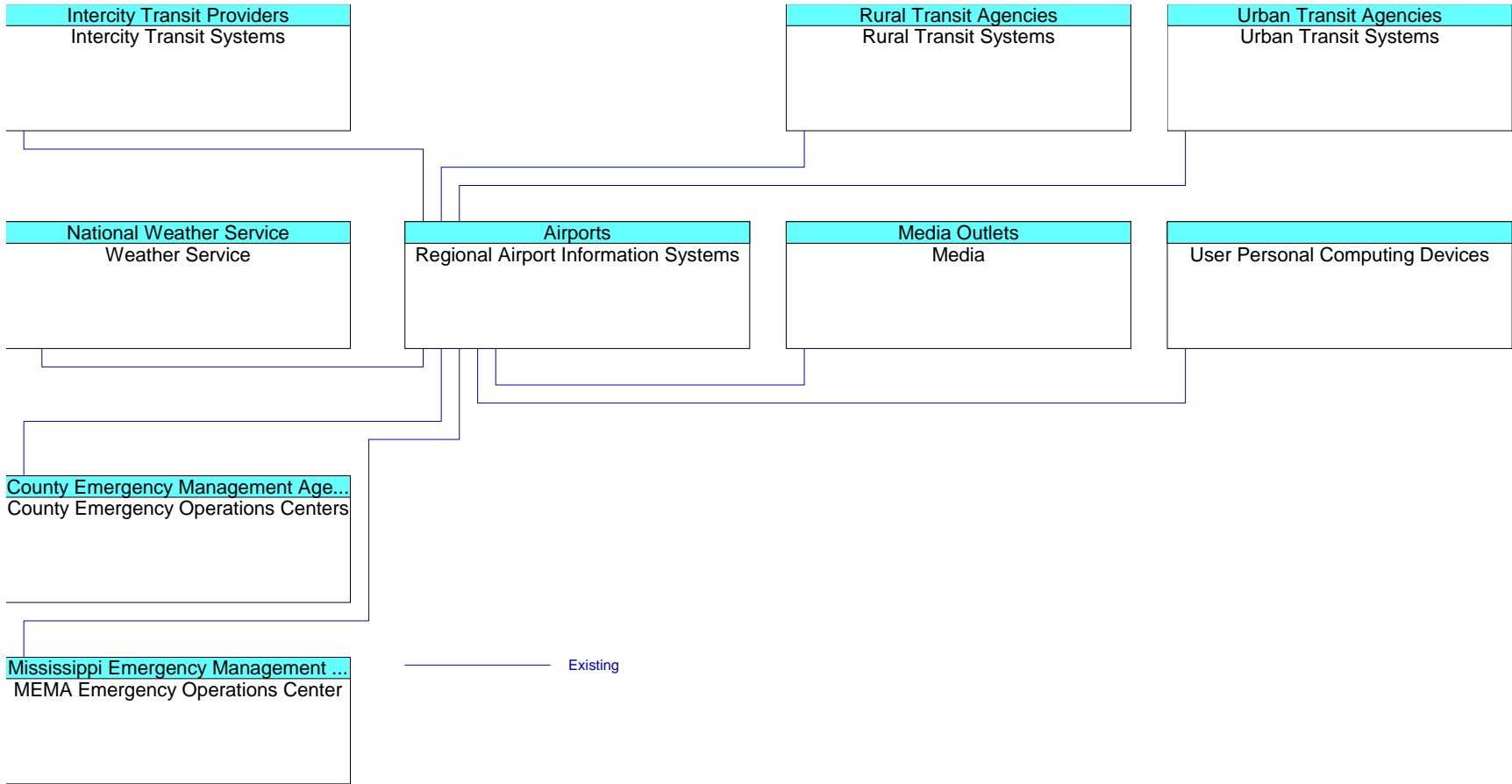

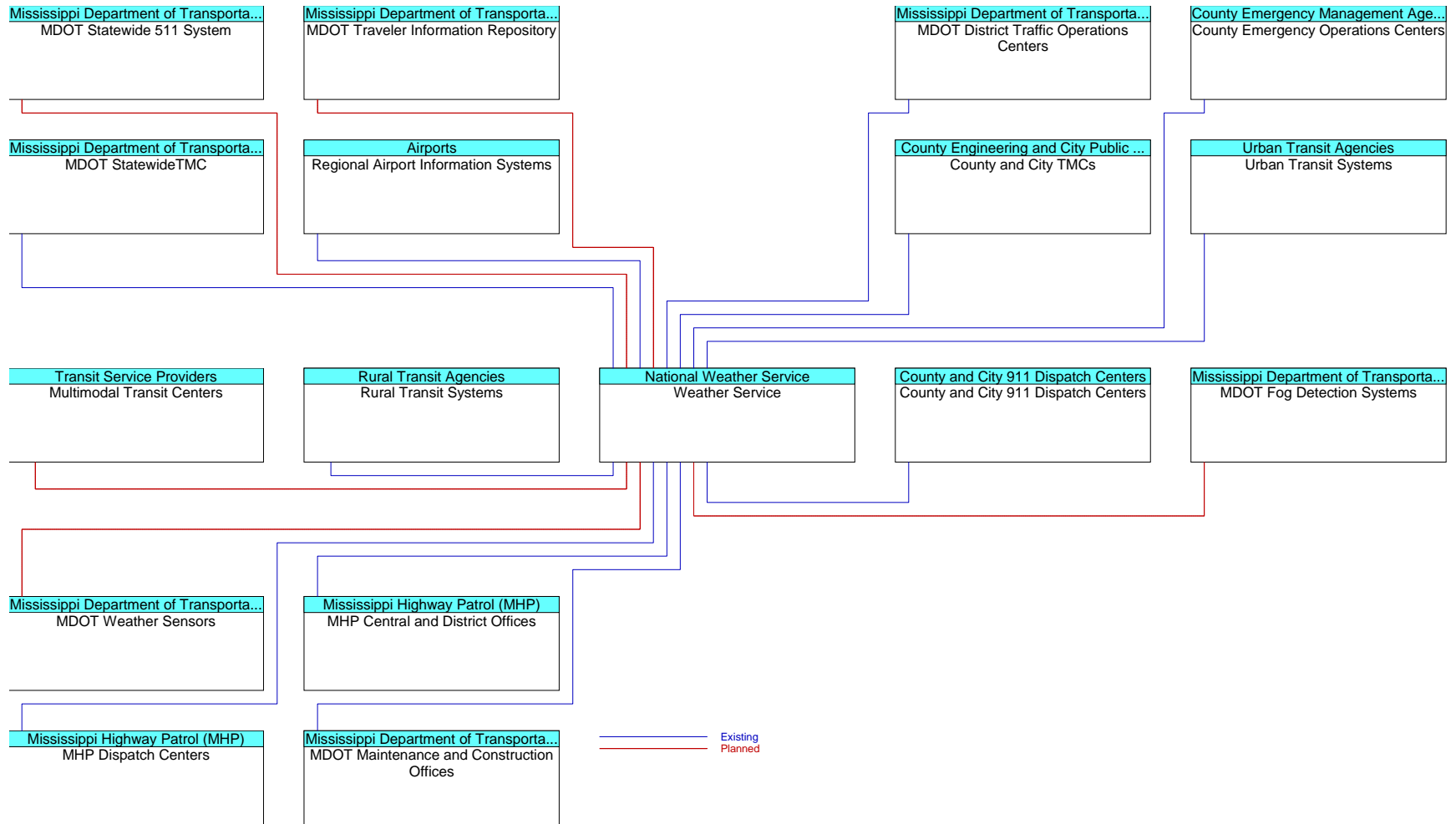

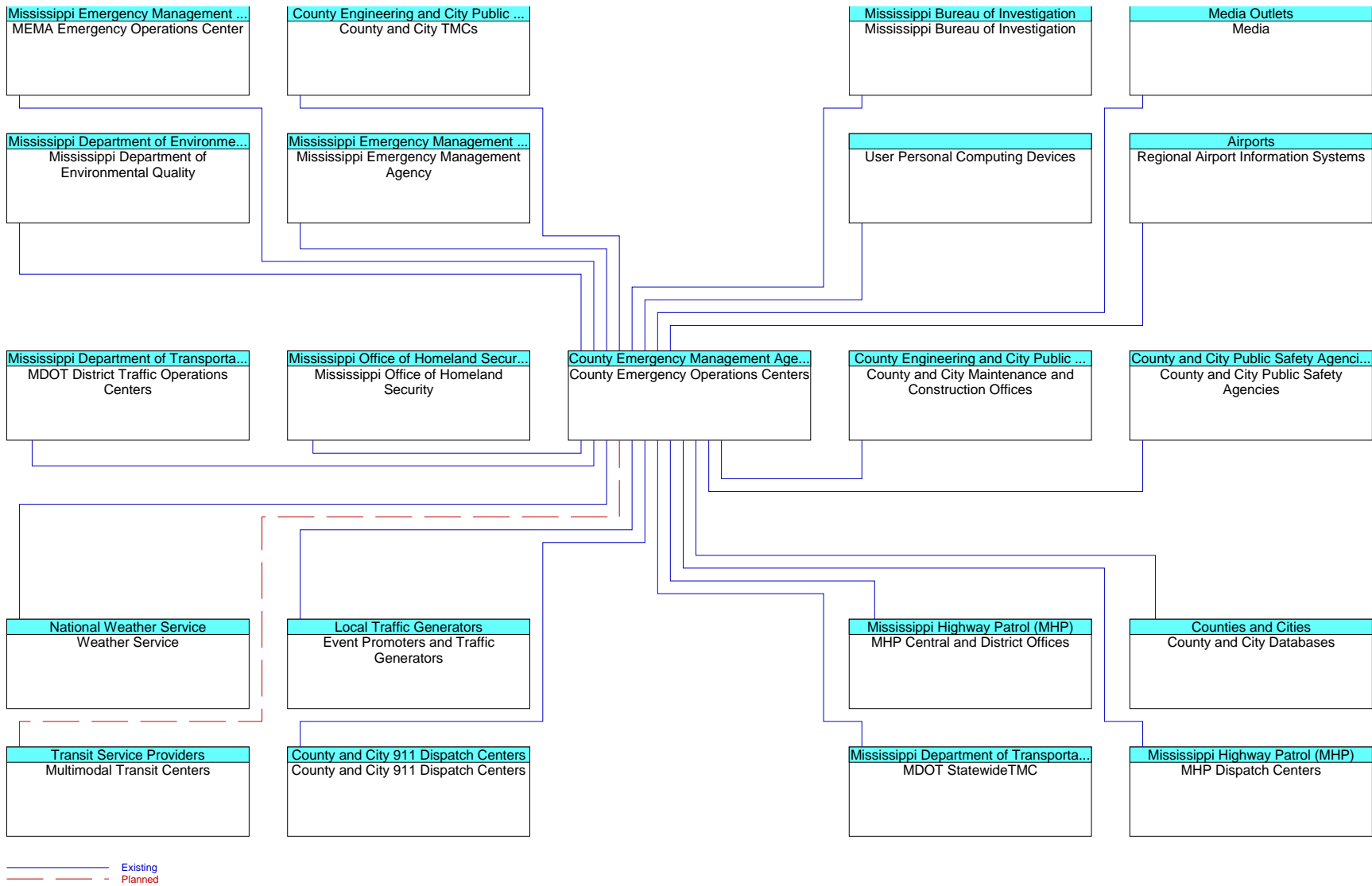

C-39

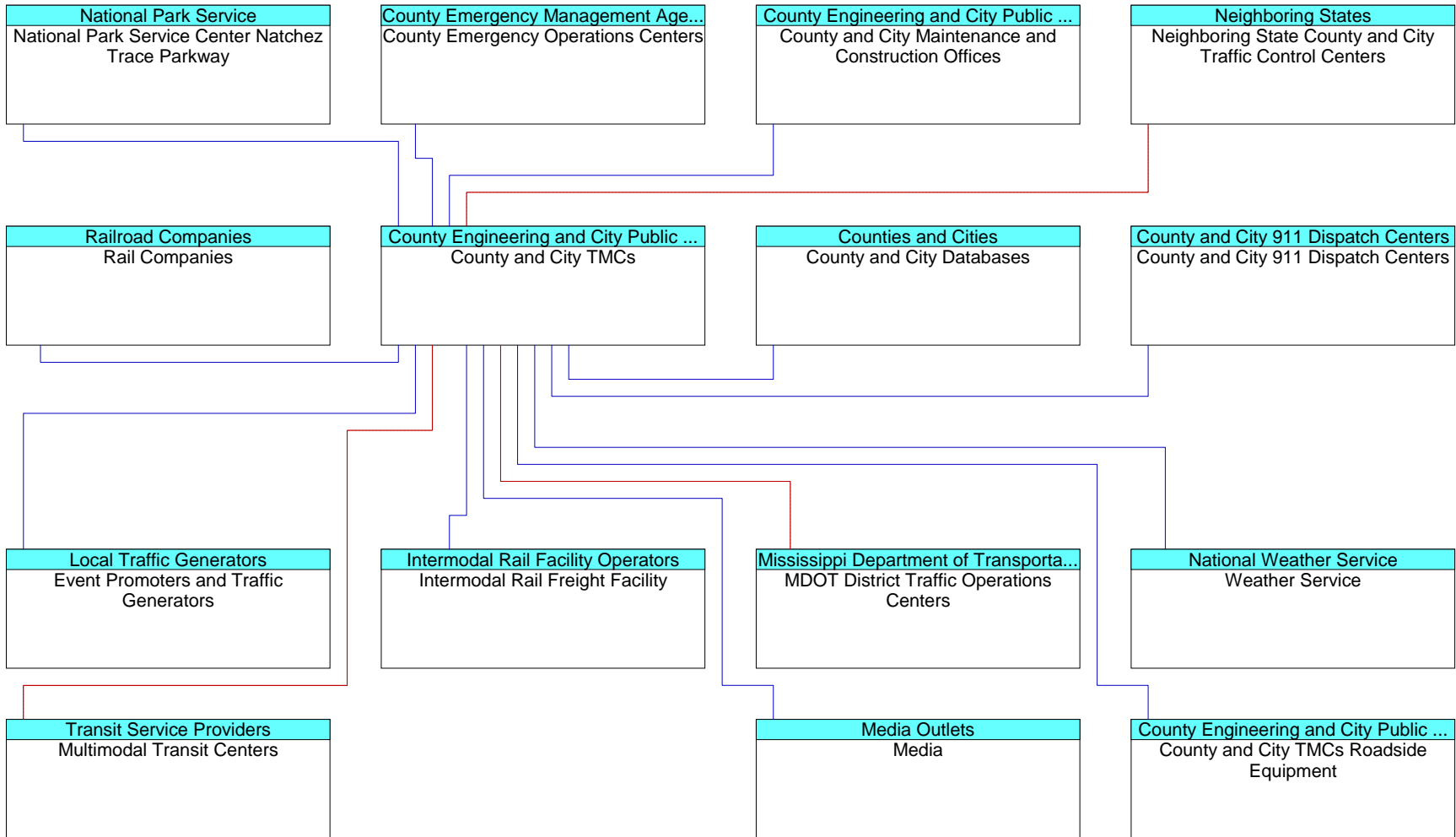

Existing  
Planned

C-40

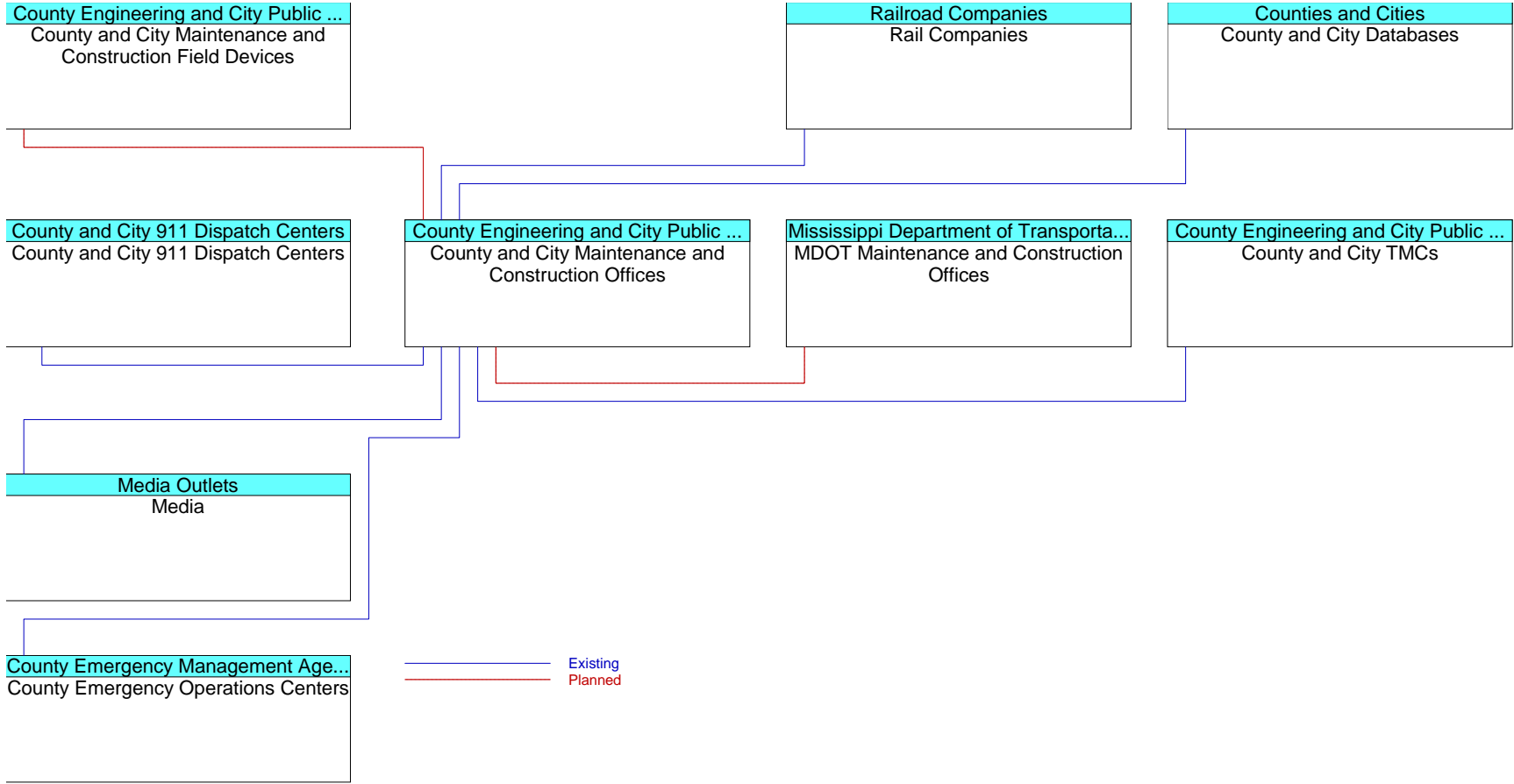

C-41

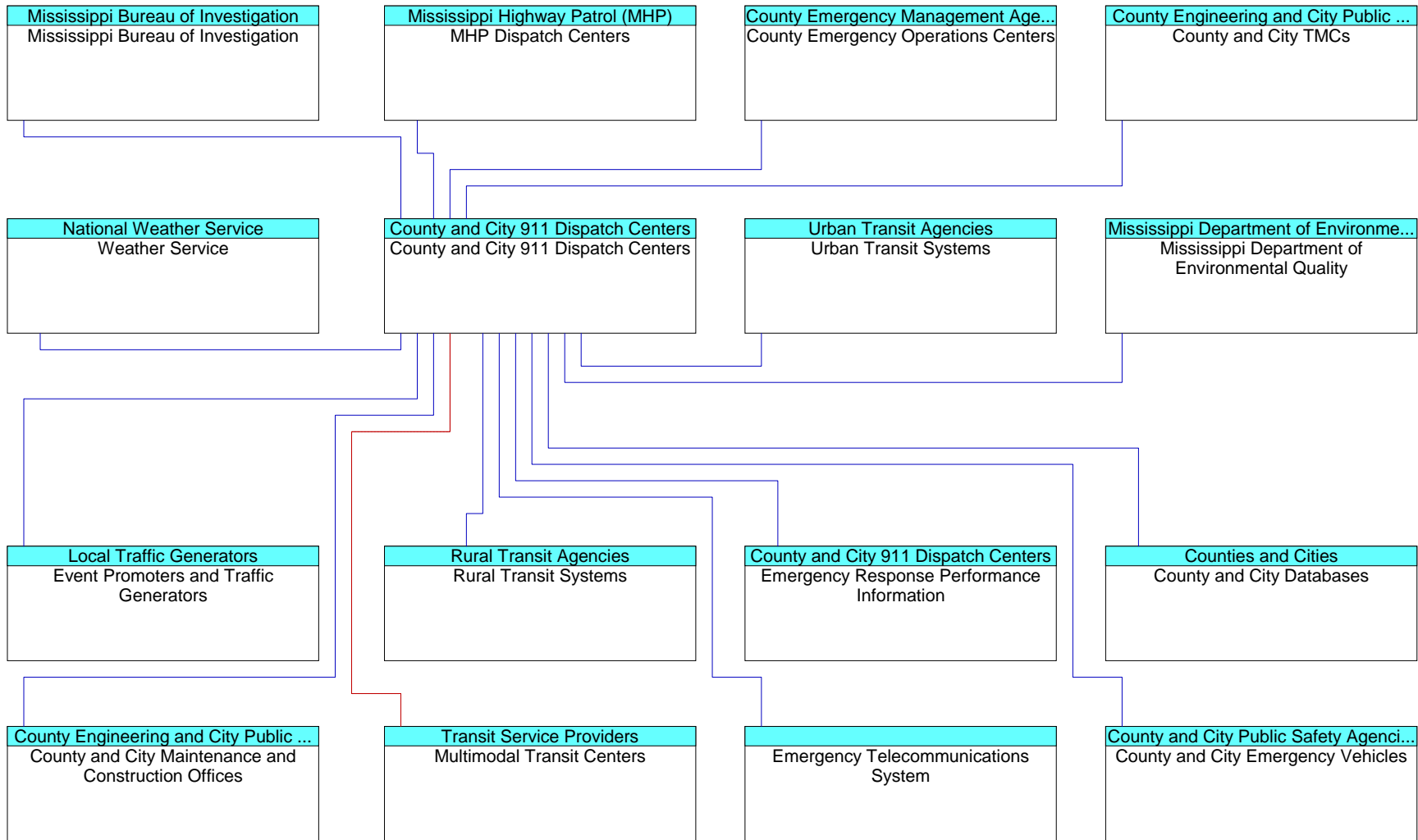

— Existing  
— Planned

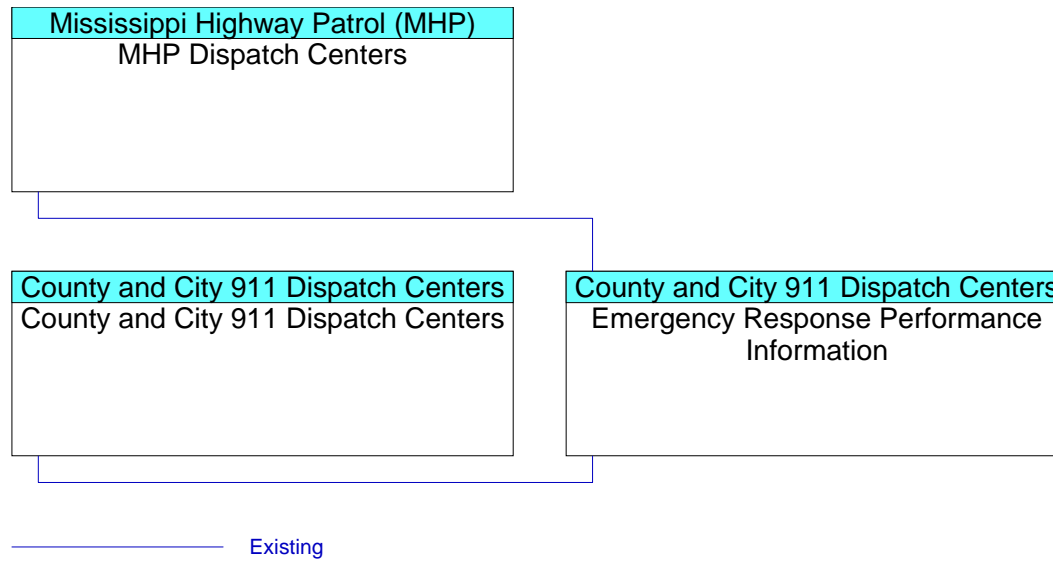

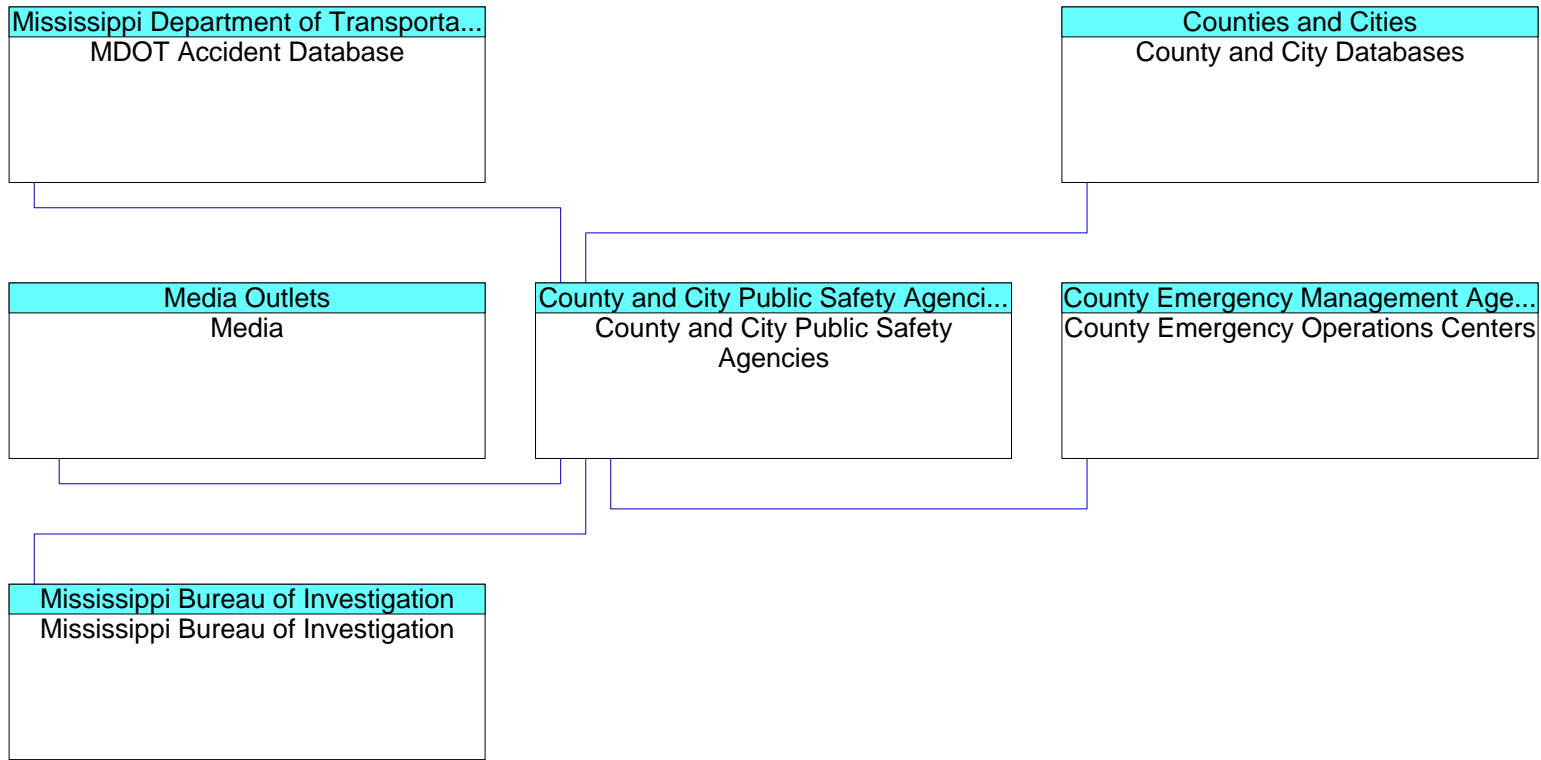

Existing

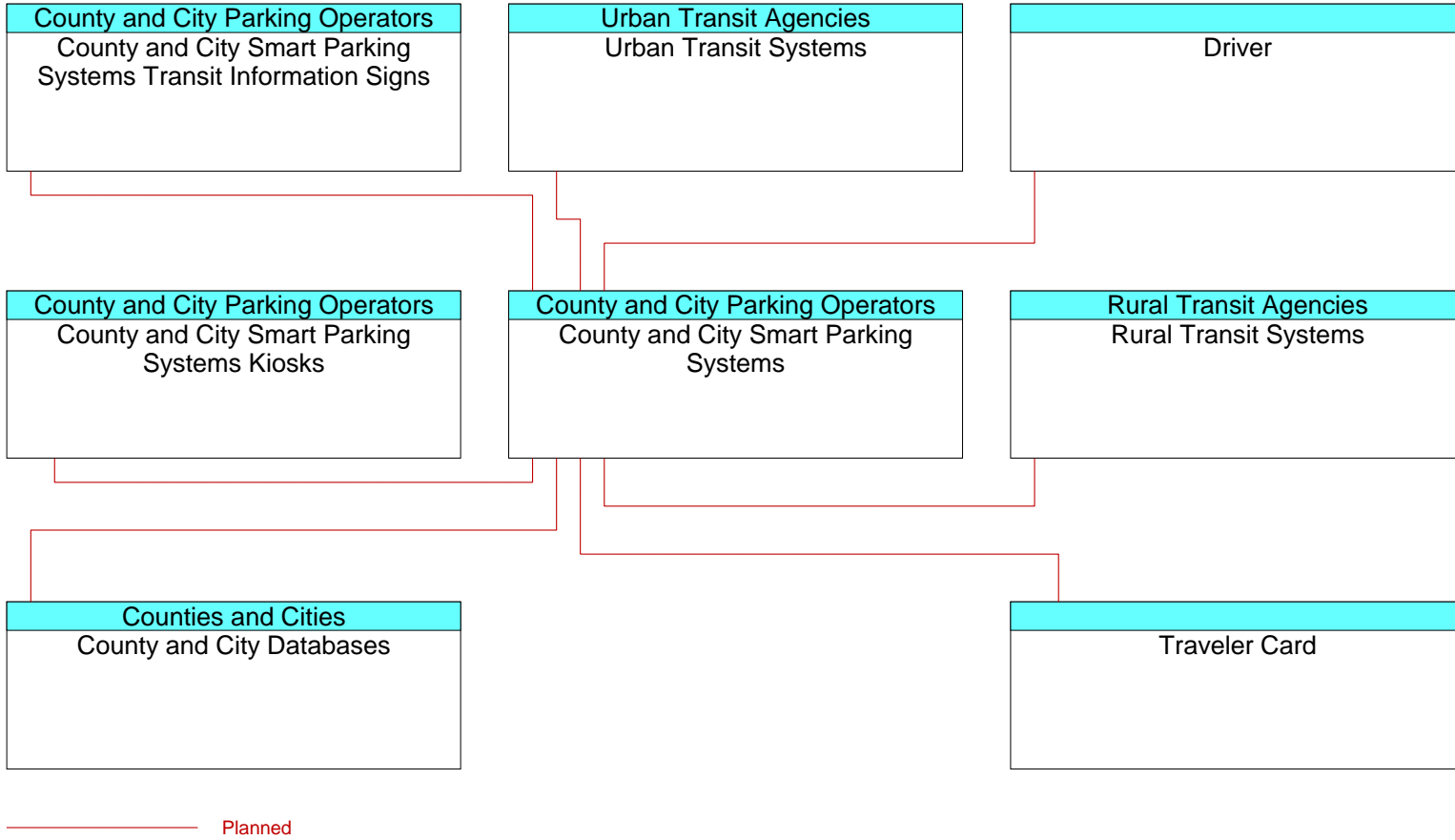



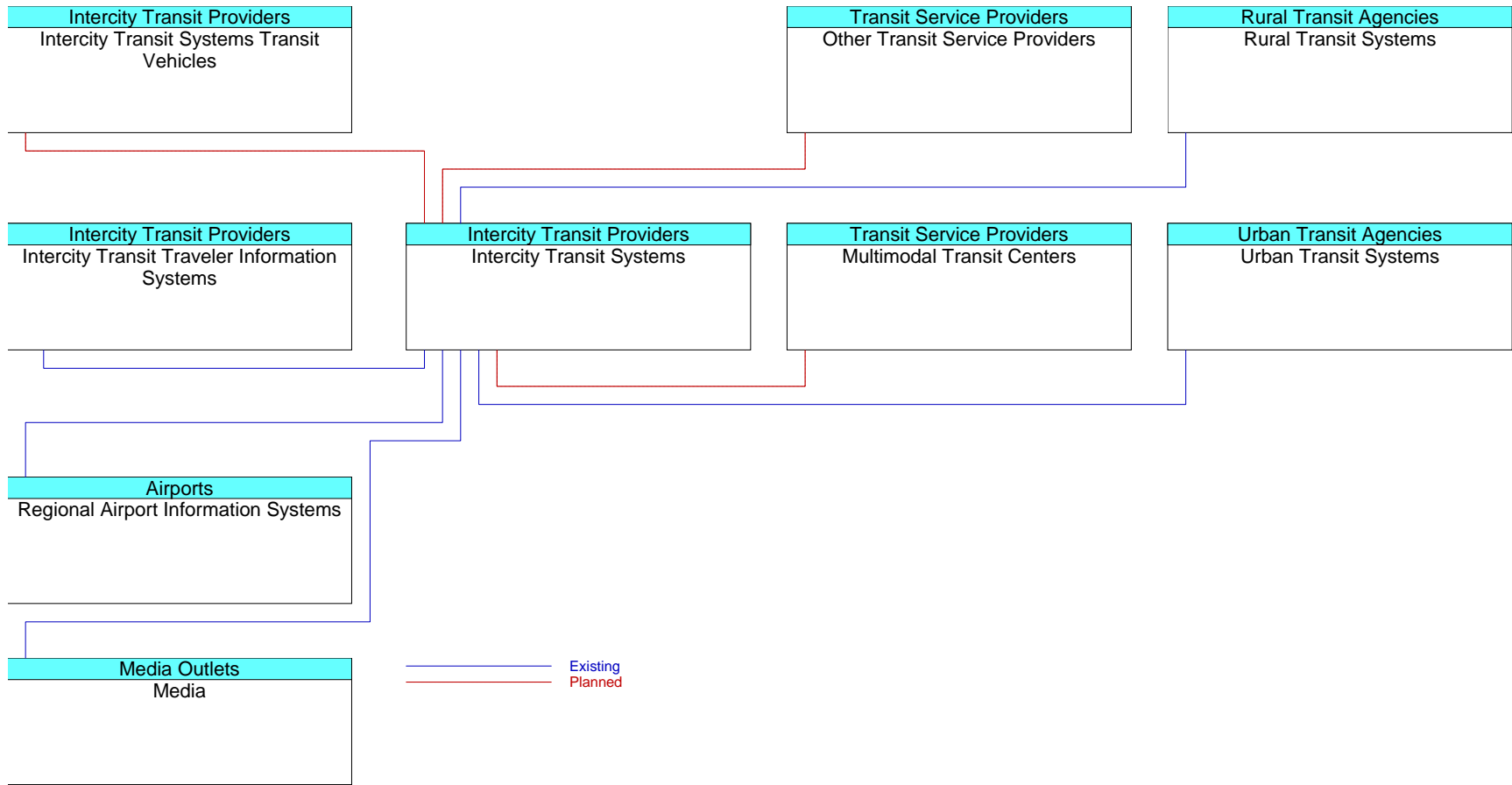

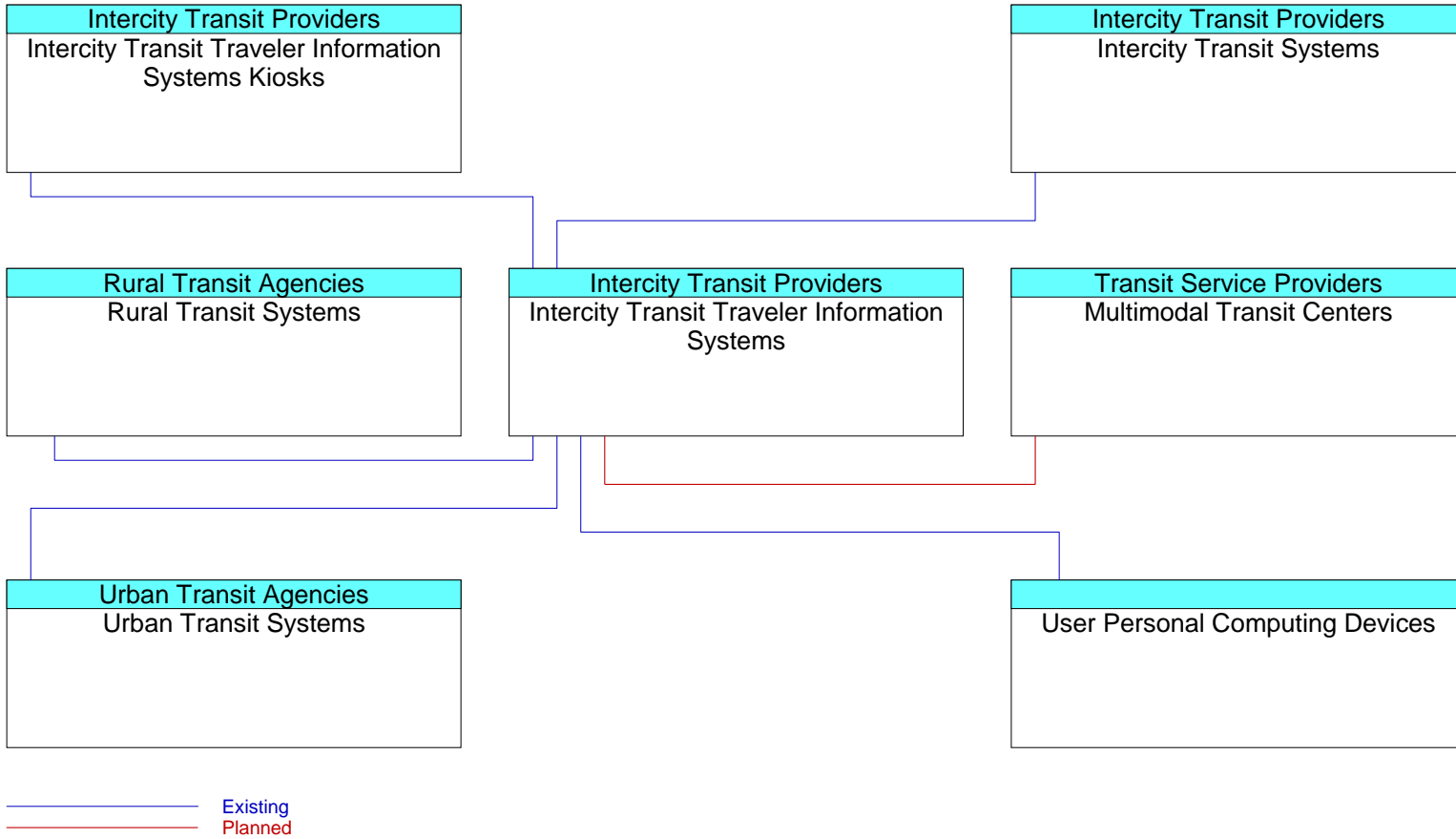



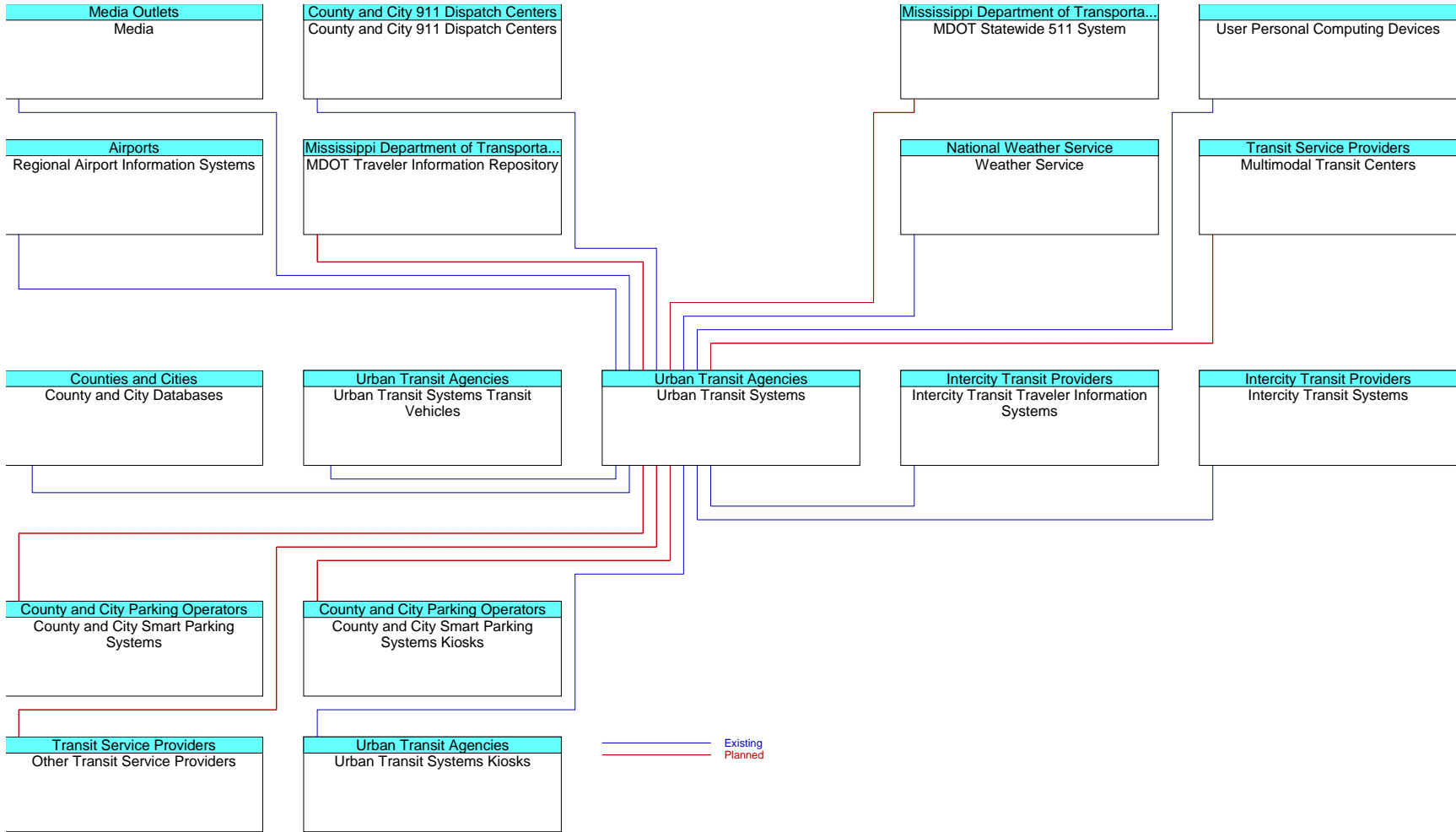

C-50

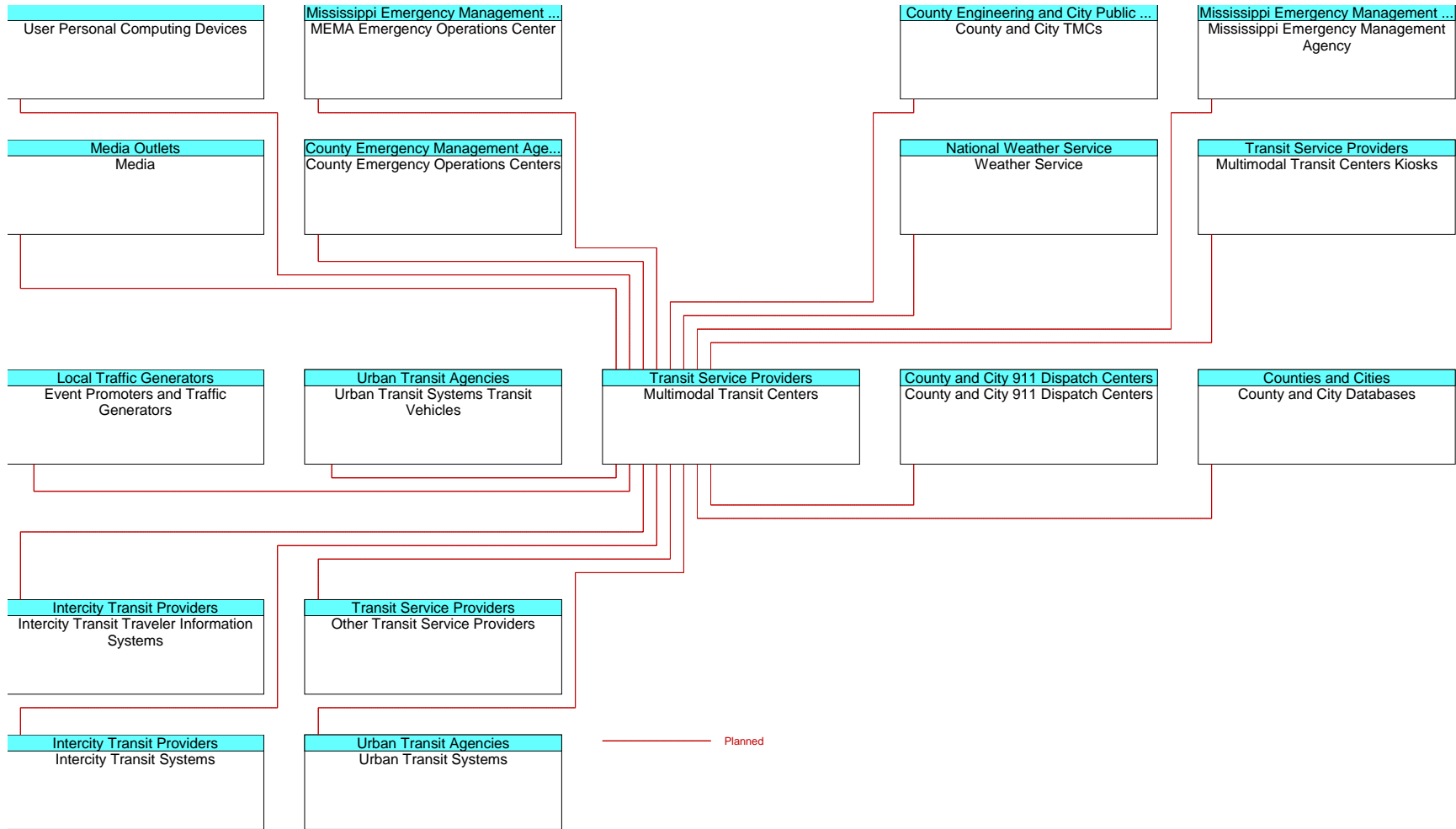

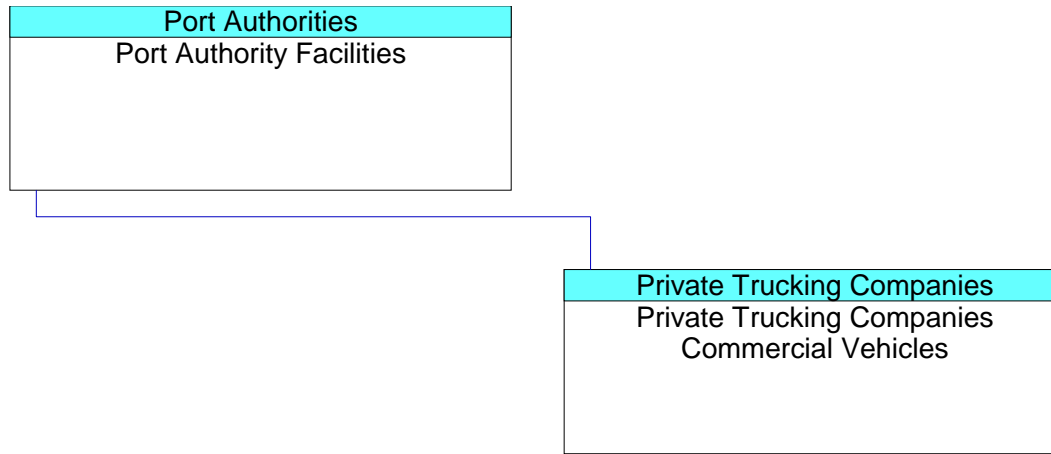

Existing

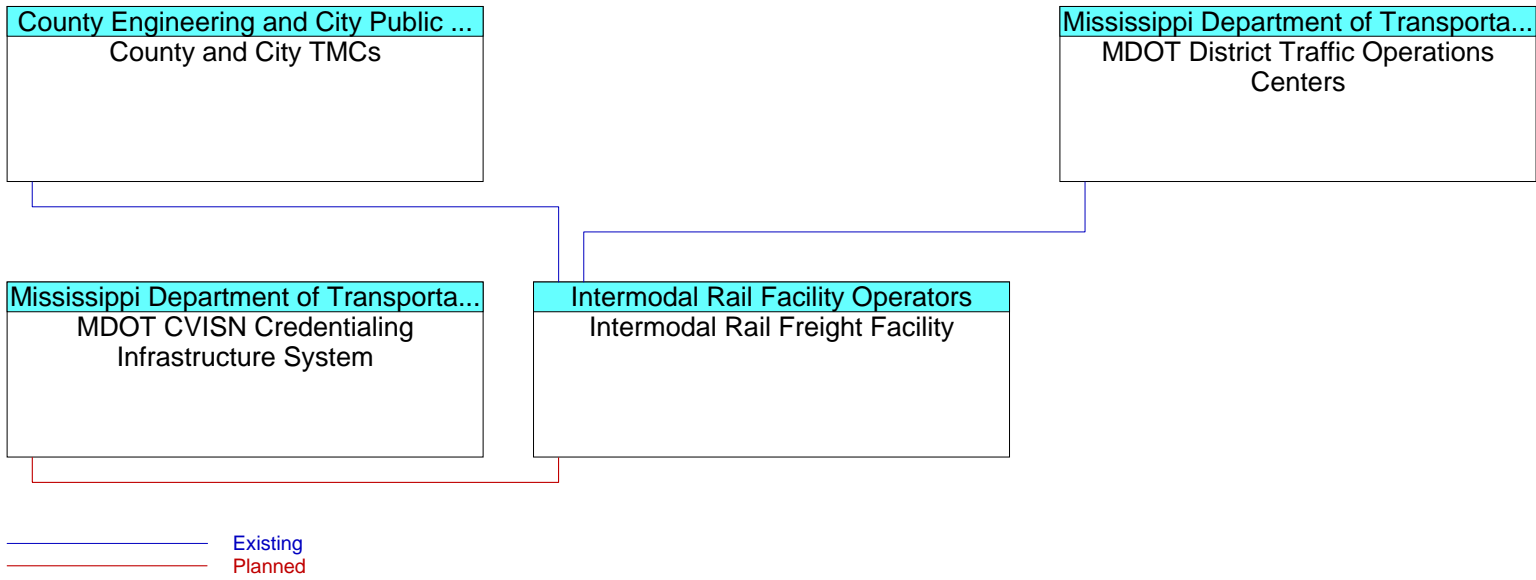

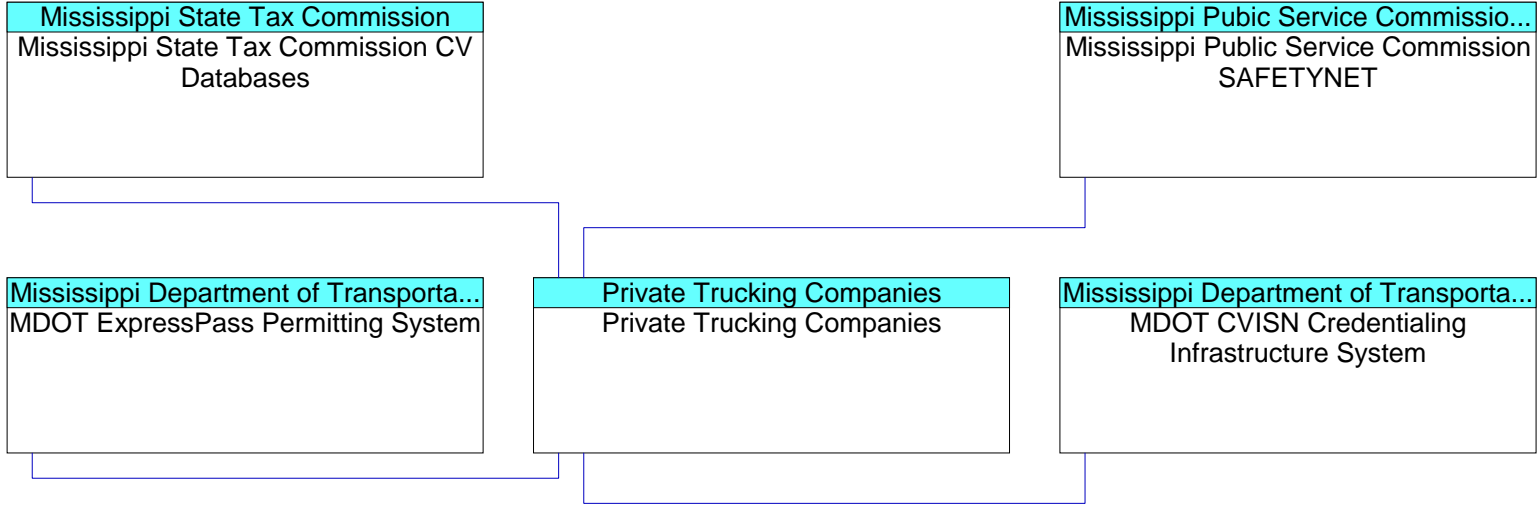

Existing

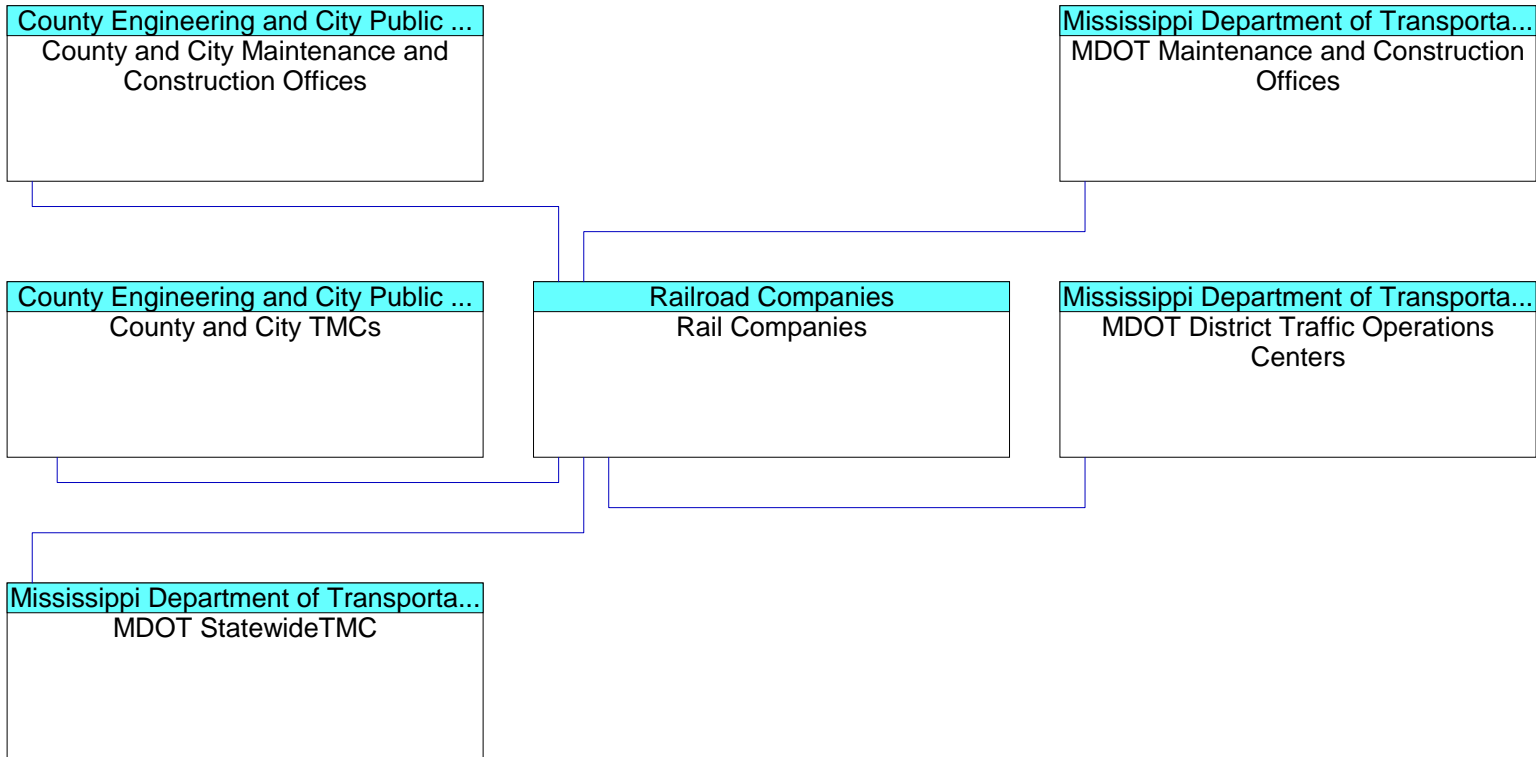

Existing

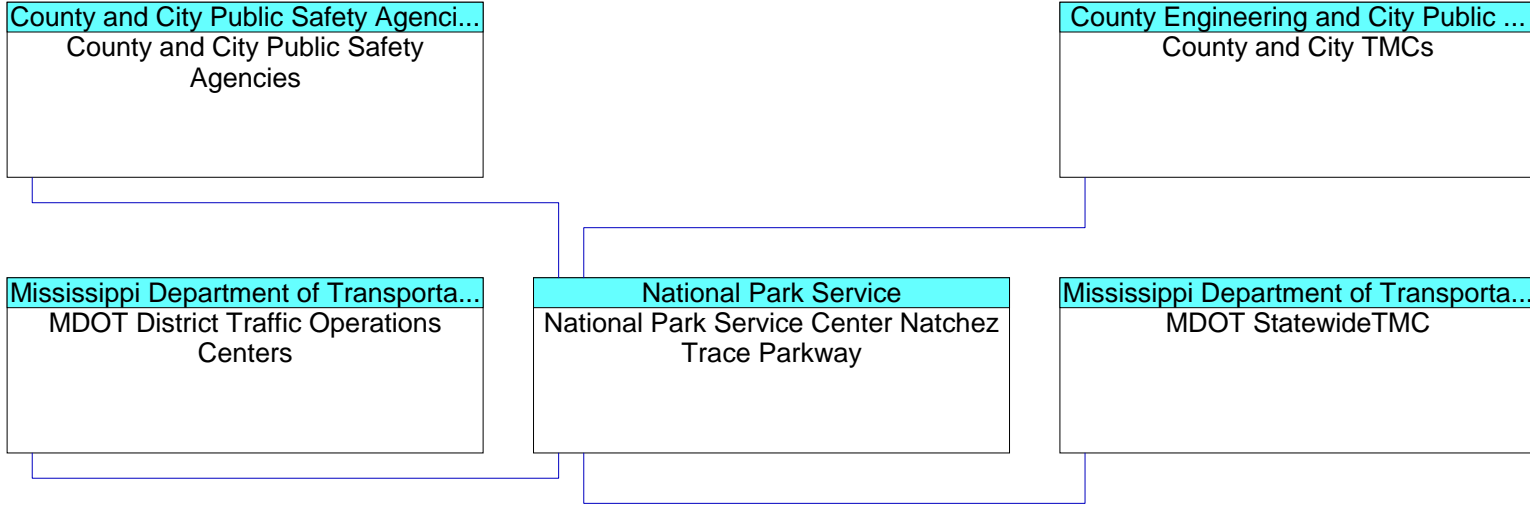

Existing

**Page Left Blank Intentionally**